

# COMMERCIAL BROCHURE

**TOTO**

Life Anew

# TOTO

## NX SUITE

### WELCOME

#### TOTO CLEANOVATION

Clean gives peace of mind  
Clean makes life beautiful  
Clean feels refreshing  
Clean is caring for people and the planet  
Clean brings wellness to everyday life

TOTO renovation brings a new world of clean to life,  
enriching every moment of every day.

#### TOTO CLEANOVATION CLEAN SYNERGY

THE NEXT STEP THE NEXT STEP THE NEXT STEP

VISIT TOTO'S FIRST-EVER  
**VIRTUAL SHOWROOM**



[VIRTUALSHOWROOM.TOTOUSA.COM](http://VIRTUALSHOWROOM.TOTOUSA.COM)



# TOUR OUR VIRTUAL SHOWROOM

TOTO's experiential virtual showroom is filled with rich informational videos, dynamic booth sections, and 360-degree product demonstrations.



# TOTO CLEANOVATION

Clean gives peace of mind

Clean makes life beautiful

Clean feels refreshing

Clean is caring for people and the planet

Clean brings wellness to everyday life

TOTO innovation brings a new world of clean to life,  
enriching every moment of every day.





# CONTENTS

## ICONS

---

**5** Icon Guide

## TOILETS & URINALS

---

**08** 1G® Toilet Innovation and Technology Highlights  
**09** Urinals and Flush Valves Technology Highlights  
**10** Toilets Comparison Chart  
**11** 1G Toilets  
**13** 1.28 GPF Toilets  
**15** Flushometer HET  
**16** Toilet Seats  
**16** Urinal Flush Valve Compatibility Chart  
**17** Washout Ultra HEU  
**18** Washout HEU

## RECLAIMED WATER PRODUCTS

---

**19** Reclaimed Water Innovation and Technology  
**20** Reclaimed Water Flushometer Toilets  
**21** ECOPOWER® HET Flush Valve  
**22** Reclaimed Water HEU  
**23** ECOPOWER Ultra HET Flush Valve  
**23** ECOPOWER Urinal Flush Valve

## TOUCHLESS RESTROOMS

---

**26** Clean and comfortable experience

## FLUSH VALVES

---

**28** ECOPOWER Flush Valves  
**31** ECOPOWER Urinal Flush Valves  
**31** Manual Flush Valve

## FAUCETS

---

**32** ECOPOWER Faucets Innovation & Technology  
**34** ECOPOWER Faucet Identification Chart  
**36** Axiom®  
**36** GC  
**37** GE  
**37** GM  
**37** Gooseneck  
**38** Helix®  
**38** Libella®  
**39** Standard R  
**39** Standard S  
**39** Touchless Faucet Controller with Heater

## SOAP DISPENSERS

---

**41** Sensor Operated Soap Dispensers  
**41** TOTO Soap

## LAVATORIES

---

**42** Innovation & Technology Highlights  
**43** Arvina® Vessel  
**44** Undercounter  
**45** Rendezvous  
**45** Dantesca  
**45** Atherton™  
**46** Undercounter  
**48** Wheelchair User's Lavatories

## CLEAN DRY® HAND DRYERS

---

**50** Innovation & Technology Highlights  
**51** Hand Dryers Overview

## IoT SMART RESTROOM







---

**52** KOLO™ Smart Monitoring System  
**57** ECOPOWER Flush Valves Innovation and Technology  
**58** ECOPOWER Flush Valves Compatibility Chart  
**59** ECOPOWER Faucets Innovation and Technology







# ICON GUIDE

## TOILET & LAVATORY

- 
**1G**
1.0 GPF
Using only 1 gallon per flush, 1G toilets provide the most efficient flush in the industry.
- 
**TORNADO FLUSH®**
A state-of-the-art, hole-free rim design that offers dual-nozzle bowl cleansing, creating a centrifugal rinsing action that cleans the bowl more efficiently.
- 
**E+MAX®**
High performance, high-efficiency flushing technology using only 1.28 GPF with a 3" wide flush valve, large trapway, and extra-large siphon jet.
- 
**CEFIONTECT®**
Ultra-smooth ceramic glaze leaves nowhere for waste to cling.
- 
**UNIVERSAL HEIGHT**
Toilet height that allows for a more comfortable height position across a wide range of users.
- 
**SKIRTED DESIGN**
The trapway is concealed by smooth porcelain, making the toilet easier to clean.
- 
**WATER SAVING**
Water efficient toilets designed with 1.28 gallons per flush or less.

## WASHLET® +



## EFV & AUTO FAUCET

- 
**ECOPOWER®**
EcoPower indicates sensor faucets and flush valves that are powered by flowing water.
- 
**AUTO FLUSH**
No need to touch buttons or handles and never worry about someone forgetting to flush — it's automatic after each use.
- 
**SAFETY THERMO®**
Shape Memory Alloy (SMA) thermostatic valve that prevents a sudden, unwanted increase in water temperature.
- 
**SOFTFLOW**
This advanced water technology precisely balances individual streams of water to gently caress the skin with virtually no splash. The beautiful translucent water streams are soft, luxurious, and visually pleasing.

## CODES & STANDARDS

- 
**ADA**
Product complies with Americans with Disabilities Act guidelines.
- 
**WATERSENSE®**
Product that meets EPA standards for water efficiency and performance criteria.
- 
**CEC**
Product meets California Energy Commission requirements.
- 
**GREEN SEAL™**
Product meets Green Seal certification requirements.
- 
**CALGreen**
Product meets CalGreen Water Regulations for new construction and permitted remodel.

## AWARDS

- 
**REDDOT DESIGN AWARD**
An internationally renowned design award since 1955. Held at Design Zentrum Nordrhein Westfalen in Essen, Germany. Products that have been strictly examined and recognized by design experts against standards of innovativeness, functionality, quality, and so forth.
- 
**IF DESIGN AWARD**
An internationally renowned design award since 1953. It is held at iF International Forum design GmbH in Hannover, Germany. Products whose aesthetics, functionality, and innovativeness have been strictly examined and recognized by design experts.
- 
**GREEN GOOD DESIGN AWARD**
Hosted by the Chicago Athenaeum Museum of Architecture and Design and the European Centre for Architecture Art Design and Urban Studies in Ireland. A global environmental award that began in 2009 with the aim of reforming awareness through sustainable design.

# TOTO EVERYWHERE



**TOTO CAN TAKE CARE  
OF YOU EVERYWHERE.**

TOTO products can create beautiful, refreshing bathroom experiences in any situation. We design everything from urinals to hand dryers, so even a football stadium or an airport restroom can be a peaceful, inspiring escape.

We're known for consistent high-performance design and a beautiful, global aesthetic in all our products, so wherever you find TOTO you can experience the same reliability, value and style.



SENSOR  
FAUCETS



TOILETS



URINALS



FLUSH VALVES



LAVATORIES

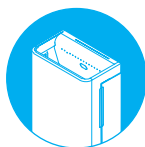

HAND DRYERS

In today's fast-paced world, the need for superior performance and reliability means everything. And when it comes to busy commercial buildings, TOTO products are the only choice. We design world-class, eco-friendly plumbing products that help you save water and money without sacrificing an ounce of performance.

**CERTIFICATION & COMPLIANCE**

TOTO offers a full range of bathroom products that can help professionals in the commercial industry earn LEED points toward certification.

LEED is an internationally recognized green building certification system that provides third-party verification for a building or community. To get maximum LEED points, a new or existing building must reach specified water-usage reduction percentages. The more usage reductions, the more LEED points are earned.



**THE AMERICANS WITH DISABILITIES ACT (ADA)**

The Americans with Disabilities Act (ADA) was enacted in 1990 to establish design codes to serve people of all ages and abilities. A core principle behind TOTO Total Design, ADA standards consider the needs of everyone without additional adaptation or specialization, optimizing the bathroom experience for all generations in the family home.

By innovating ergonomics and accessibility, and combining them with our global design aesthetic, we give everyone everything that’s great about TOTO.

**ENVIRONMENTAL RESPONSIBILITY**

TOTO plays a significant role in leading the sustainability charge in our industry. In fact, our active role in leading policy and certification organizations demonstrates how we go beyond products or practices to help ensure environmental responsibility across all company activities.

- TOTO is the only plumbing manufacturer to receive the EPA’s Water Efficiency Leader Award
- TOTO was the first plumbing products manufacturer to have employees become sustainability experts by gaining LEED Accredited Professional status
- TOTO was the first major plumbing products manufacturer to join the United States Green Building Council (USGBC)
- TOTO was the first plumbing products manufacturer to develop third-party verified LCA Transparency Reports for bath products.



EPA WaterSense Partner



United States Green Building Council



Water Efficiency Leader Award



Environmental Protection Agency



LEED AP



Argon Award



Meets California Water Savings Regulations





ONE GALLON  
PER FLUSH

## 1G® TOILETS 1.0 GPF

TOTO's 1G toilets are a perfect solution to help owners and managers of hospitality and multi-family housing properties address their water conservation challenges. The powerful, yet quiet 1G system offers a 35 percent savings over 1.6 GPF toilets — a substantial savings without wavering on our renowned performance.



Reduces water use by 35% or more on average over a standard 1.6 GPF toilet



### TOTO 1G TOILETS



**5,840 GALLONS**  
Used in Flushing

**\$175** Operation  
Cost

**PER YEAR**

VS.

### STANDARD 1.6 GPF TOILETS



**9,344 GALLONS**  
Used in Flushing

**\$280** Operation  
Cost

**PER YEAR**

\*The average American flushes five times a day at home. Assuming an average household of 3.2 people over 365 days @ 3¢ per gallon.



# COMMERCIAL TOILETS, URINALS & FLUSH VALVES

Innovation & Technology Highlights

## THE TOTO ADVANTAGE

- Thorough and extensive testing to ensure balanced flushing
- HETs use 1.28 GPF
- HEUs use as little as 0.125 GPF
- TOTO toilet and urinal fixtures are designed for efficient operation, ensuring the highest performance with the lowest consumption levels.

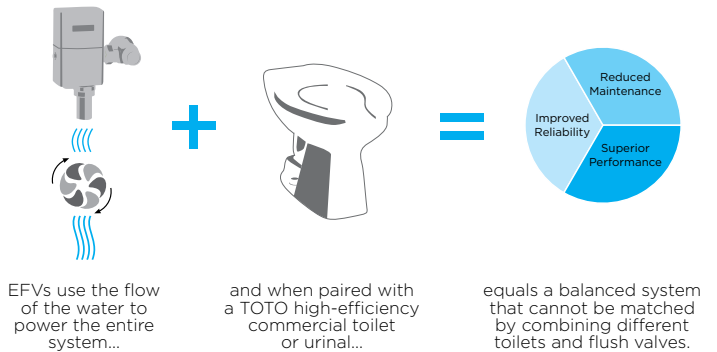

## CEFIONTECT®

- Extraordinarily smooth glaze prevents particulates from adhering to ceramic surfaces
- CEFIONTECT keeps surfaces cleaner, longer
- Less cleaning means less water use and fewer chemicals in the environment

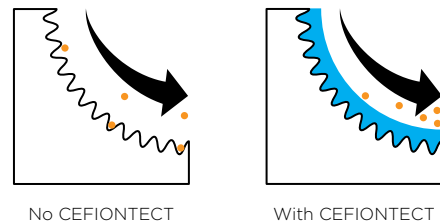

## ECOPOWER® FLUSH VALVES

- Hydroelectric turbine uses water to create power
- ECOPOWER flush valves provide maximum performance in high-traffic commercial spaces
- Self-powering eliminates costs of installing electrical supplies and wiring
- No routine battery replacement means less maintenance costs

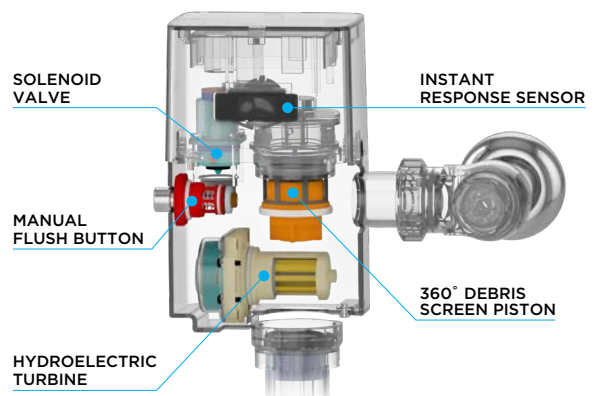

# TOILETS COMPARISON CHART

	SKU#			MIN. ROUGH-IN	BOWL			SEAT HEIGHT	RECOM. SEAT	FLUSH. SYSTEM	GPF					OTHER**	+			
	KIT	BOWL	TANK		ELON.	ROUN.	Sp				1G (3.8L)	1.28 (4.8L)	1.6 (6L)	DUAL						
CARLYLE II 1G	MS614124CUFG	N/A	N/A	12" (10"-14")	•		•	UNIVERSAL	SSI24 included		•				•	•	•	•	R	•
ULTRAMAX II 1G	MS604124CUFG	N/A	N/A	12"	•			UNIVERSAL	SSI24 included		•				•	•	•	•	R	•
VESPIN II 1G	CST474CUF(G)	CT474CUF(G)	ST453U	12" (10"-14")	•		•	UNIVERSAL	SSI14		•				**	•	•	•	R	•
DRAKE II 1G	CST454CUF(G)	C454CUF(G)	ST453U	12"	•			UNIVERSAL	SSI14		•				**	•	•	•	R	•
	CST453CUF(G)	C453CUF(G)	ST453U	12"		•		UNIVERSAL	SSI13		•				**	•	•	•	R	•
DRAKE II	CST454CEF(G)	C454CUF(G)	ST454E	12"	•			UNIVERSAL	SSI14			•			**	•	•	•	R	•
	CST453CEF(G)	C453CUF(G)	ST454E	12"		•		UNIVERSAL	SSI13			•			**	•	•	•	R	•
DRAKE	CST776CEF(G)	C776CEF(G)	ST776EA	12"	•			UNIVERSAL	SSI14			•			•	•	•	•	R,B,D,DB	•
	CST776CSF(G)	C776CEF(G)	ST776SA	12"	•			UNIVERSAL	SSI14				•		•	•	•			•
	CST776CE(G)	C776CE(G)	ST776EA	12"	•			REGULAR	SSI14			•			•			•	R,B,D,DB	•
	CST776CS(G)	C776CE(G)	ST776SA	12"	•			REGULAR	SSI14				•		•					•
	CST776CEFG.10	C776CEFG.10	ST776EA	10"	•			UNIVERSAL	SSI14			•			•	•	•	•	R,B,D,DB	•
	CST776CSFG.10	C776CEFG.10	ST776SA	10"	•			UNIVERSAL	SSI14				•		•	•	•			•
	CST775CEF(G)	C775CEF(G)	ST776EA	12"		•		UNIVERSAL	SSI13			•			•	•	•	•	R,B,D,DB	
DRAKE TRANSITIONAL	CST786CEMF(G)	C776CEF(G)	ST786EA	12"	•			UNIVERSAL	SSI14			•			•	•	•	•		•
	CST786CEM(G)	C776CE(G)	ST786EA	12"	•			REGULAR	SSI14			•			•			•		•
	CST786CEMFG.10	C776CEFG.10	ST786EA	10"	•			UNIVERSAL	SSI14			•			•	•	•	•		•
	CST785CEF(G)	C775CEF(G)	ST786EA	12"		•		UNIVERSAL	SSI13			•			•			•		•
ENTRADA	CST244EF	C244EF	ST243E	12"	•			UNIVERSAL	SSI14			•			•	•	•	•	R	•
	CST243EF	C243EF	ST243E	12"		•		UNIVERSAL	SSI13			•			•		•	•	R	•

\*#51: Without CEFIONTECT  
 \*\*R: Right Hand Trip Lever available  
 \*\*B: Bolt Down Lid available  
 \*\*D: Insulated Tank available  
 \*\*DB: Insulated Tank and Bolt Down Lid available  
 \*\*RB: Right Hand Trip Lever and Bolt Down Lid available

# TOILET FLUSH VALVE COMPATIBILITY CHART

				FLUSHOMETER								
				ECOPOWER®			MANUAL					
				1.0 GPF	1.28 GPF	1.6 GPF	1.28 GPF	1.6 GPF				
TOILET	Floor Mounted Top Spud	CT725CU(G)	Exposed	TET1UB32#CP TET6UB32#CP	TET1LB32#CP TET6LB32#CP	TET1GB32#CP TET6GB32#CP	TMTILN32#CP	TMTINNC-32				
			Concealed	TET2UB32#SS TET3UB32#SS	TET2LB32#SS TET3LB32#SS	TET2GB32#SS TET3GB32#SS						
			Floor Mounted Top Spud	CT725CUF(G)	Exposed	TET1UB32#CP TET6UB32#CP			TET1LB32#CP TET6LB32#CP	TET1GB32#CP TET6GB32#CP	TMTILN32#CP	TMTINNC-32
					Concealed	TET2UB32#SS TET3UB32#SS			TET2LB32#SS TET3LB32#SS	TET2GB32#SS TET3GB32#SS		
	Wall-Mounted Top Spud	CT728CU(G)	Exposed	TET1UB32#CP TET6UB32#CP	TET1LB32#CP TET6LB32#CP	TET1GB32#CP TET6GB32#CP	TMTILN32#CP	TMTINNC-32				
			Concealed	TET2UB32#SS TET3UB32#SS	TET2LB32#SS TET3LB32#S	TET2GB32#SS TET3GB32#SS						
			Wall-Mounted Back Spud	CT728CUV(G)	Concealed	TET2UB31#SS TET3UB31#SS			TET2LB31#SS TET3LB31#SS	TET2GB31#SS TET3GB31#SS	-	

# 1G 1.0 GPF TOILETS OVERVIEW

## CARLYLE® II 1G® ONE-PIECE TOILET 1.0 GPF

MS614124CUF(R)(G)



## ULTRAMAX® II 1G ONE-PIECE TOILET 1.0 GPF

MS604124CUF(R)(G)



## VESPIN® II 1G TWO-PIECE TOILET 1.0 GPF

CST474CUF(R)(G)



Available Q4 2021



- ▶ TORNADO FLUSH®, ultra high-efficiency (1.0 GPF/3.8 LPF)
- ▶ CEFIONTECT® ceramic glaze
- ▶ ADA Compliant
- ▶ Universal Height
- ▶ Decorative one-piece toilet with high profile design
- ▶ Elongated front bowl with SoftClose® seat (SS114)
- ▶ Standard 12" rough-in, less supply
- ▶ Optional 10" and 14" rough-in available
- ▶ Chrome trip lever
- ▶ Meets water efficiency and performance standards
- ▶ Skirted design
- ▶ WASHLET®+ models available

- ▶ TORNADO FLUSH, ultra high-efficiency (1.0 GPF/3.8 LPF)
- ▶ CEFIONTECT ceramic glaze
- ▶ ADA Compliant
- ▶ Universal Height
- ▶ Decorative one-piece toilet with high profile design
- ▶ Elongated front bowl with SoftClose seat (SS114)
- ▶ Standard 12" rough-in, less supply
- ▶ Chrome trip lever
- ▶ Meets water efficiency and performance standards
- ▶ WASHLET+ models available

- ▶ TORNADO FLUSH, ultra high-efficiency (1.0 GPF/3.8 LPF)
- ▶ CEFIONTECT ceramic glaze
- ▶ ADA Compliant
- ▶ Universal Height
- ▶ Decorative two-piece design with high-profile tank
- ▶ Elongated front bowl and tank set, less seat
- ▶ Standard 12" rough-in, less supply
- ▶ Optional 10" and 14" rough-in available
- ▶ Chrome trip lever
- ▶ Meets water efficiency and performance standards
- ▶ Skirted design
- ▶ Available in #01 Cotton only
- ▶ WASHLET+ models available

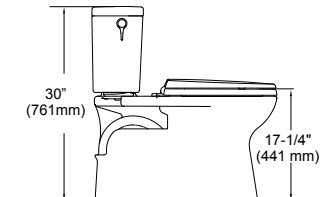
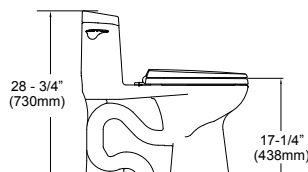
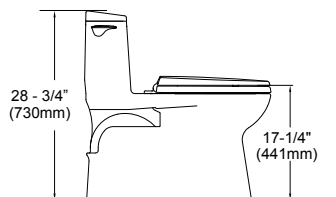
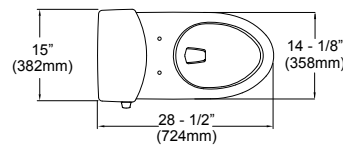
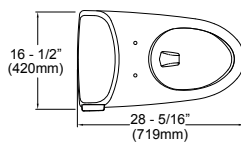
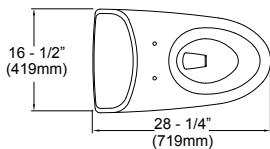

For more information on dimensions please refer to product spec sheet.

### AVAILABLE COLORS



# 1.0 GPF TOILETS OVERVIEW

## DRAKE® II 1G TWO-PIECE TOILET 1.0 GPF

CST454CUF(R)(G)



## DRAKE II 1G - ROUND TWO-PIECE TOILET 1.0 GPF

CST453CUFG(R)



- ▶ TORNADO FLUSH®, ultra high-efficiency (1.0 GPF/3.8 LPF)
- ▶ CEFIONTECT® ceramic glaze
- ▶ ADA Compliant
- ▶ Universal Height
- ▶ Decorative two-piece design with high-profile tank
- ▶ Elongated front bowl and tank set, less seat
- ▶ Standard 12" rough-in, less supply
- ▶ Chrome trip lever
- ▶ Meets water efficiency and performance standards
- ▶ WASHLET® + models available

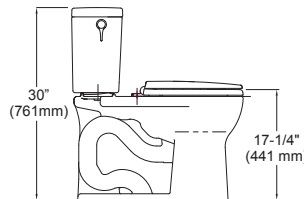
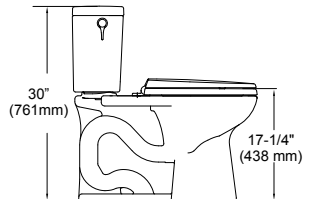
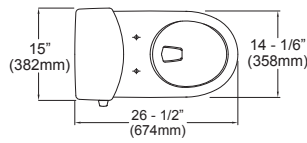
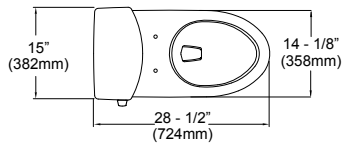

### AVAILABLE COLORS



For more information on dimensions please refer to product spec sheet.



# 1.28 GPF TOILETS OVERVIEW

**DRAKE®**  
**TWO-PIECE TOILET**  
**1.28 GPF**  
CST776CE(R)



**DRAKE**  
**TWO-PIECE TOILET**  
**1.28 GPF**  
CST776CEF(R)(G)



**DRAKE - 10"**  
**TWO-PIECE TOILET**  
**1.28 GPF**  
CST776CEF(R)(G).10



**DRAKE - ROUND**  
**TWO-PIECE TOILET**  
**1.28 GPF**  
CST775CEF(R)(G)



- ▶ TORNADO FLUSH® system, high-efficiency (1.28 GPF/4.8 LPF)
- ▶ CEFIONTECT® ceramic glaze prevents debris and mold from sticking to ceramic surfaces
- ▶ Elongated front bowl, seat sold separately
- ▶ Chrome plated trip lever
- ▶ 12" Rough-in, supply line sold separately

- ▶ TORNADO FLUSH® system, high-efficiency (1.28 GPF/4.8 LPF)
- ▶ CEFIONTECT® ceramic glaze prevents debris and mold from sticking to ceramic surfaces
- ▶ Elongated front bowl, seat sold separately
- ▶ Chrome plated trip lever
- ▶ 12" Rough-in, supply line sold separately

- ▶ TORNADO FLUSH® system, high-efficiency (1.28 GPF/4.8 LPF)
- ▶ CEFIONTECT® ceramic glaze prevents debris and mold from sticking to ceramic surfaces
- ▶ Elongated front bowl, seat sold separately
- ▶ Chrome plated trip lever
- ▶ 10" Rough-in, supply line sold separately

- ▶ TORNADO FLUSH® system, high-efficiency (1.28 GPF/4.8 LPF)
- ▶ CEFIONTECT® ceramic glaze prevents debris and mold from sticking to ceramic surfaces
- ▶ Round front bowl, seat sold separately
- ▶ Universal Height
- ▶ Chrome plated trip lever
- ▶ 12" Rough-in, supply line sold separately
- ▶ ADA compliant for residential or hospitality use

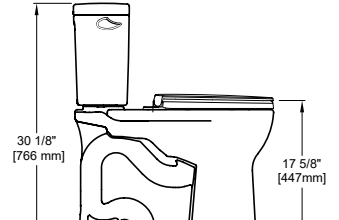
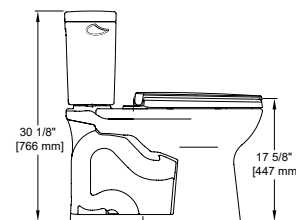
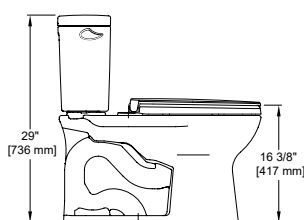
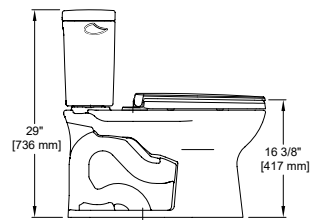
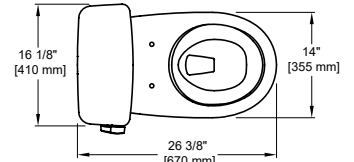
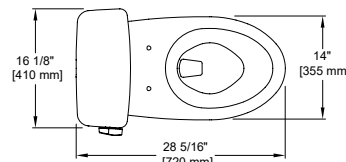
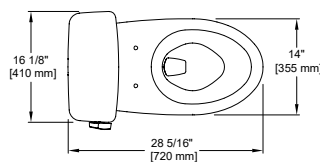
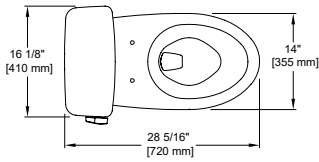

For more information on dimensions please refer to product spec sheet.

## AVAILABLE COLORS



# 1.28 GPF TOILETS OVERVIEW

## ENTRADA® TWO-PIECE TOILET 1.28 GPF

CST244EF(R) (Elongated)



- ▶ E-MAX® flushing system, high-efficiency (1.28 gpf/4.8 LPF)
- ▶ Elongated bowl
- ▶ Universal Height
- ▶ ADA compliant
- ▶ Close coupled, elongated front bowl and tank set, less toilet seat
- ▶ Chrome trip lever
- ▶ Optional right-hand trip lever(R)
- ▶ 12" Rough-in
- ▶ Available in #01 Cotton only

## ENTRADA - ROUND TWO-PIECE TOILET 1.28 GPF

CST243EF(R) (Round)



- ▶ E-MAX flushing system, high-efficiency (1.28 gpf/4.8 LPF)
- ▶ Rounded bowl
- ▶ Universal Height
- ▶ Close coupled, round front bowl and tank set, less toilet seat
- ▶ Chrome trip lever
- ▶ Optional right-hand trip lever(R)
- ▶ 12" Rough-in
- ▶ Available in #01 Cotton only

## DRAKE TRANSITIONAL TWO-PIECE TOILET 1.28 GPF

CST786CE(F)(G) (Elongated)  
CST786CEFG.10 (Elongated)



- ▶ TORNADO FLUSH® system, high-efficiency (1.28 GPF/4.8 LPF)
- ▶ Transitional style tank
- ▶ CEFIONTECT® ceramic glaze prevents debris and mold from sticking to ceramic surfaces
- ▶ Elongated front bowl, seat sold separately
- ▶ Chrome plated trip lever
- ▶ 12" and 10" Rough-in options available, supply line sold separately

## DRAKE TRANSITIONAL TWO-PIECE TOILET 1.28 GPF

CST785CEF(G) (Round)



- ▶ TORNADO FLUSH® system, high-efficiency (1.28 GPF/4.8 LPF)
- ▶ Transitional style tank
- ▶ CEFIONTECT® ceramic glaze prevents debris and mold from sticking to ceramic surfaces
- ▶ Round front bowl, seat sold separately
- ▶ Universal Height
- ▶ Chrome plated trip lever
- ▶ 12" Rough-in, supply line sold separately
- ▶ ADA compliant for residential or hospitality use

CST786CE(F)(G) (Elongated)

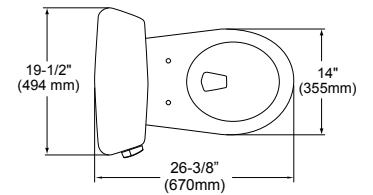
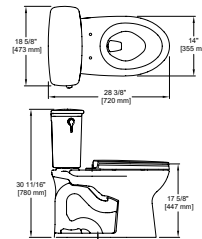

CST786CEFG.10 (Elongated)

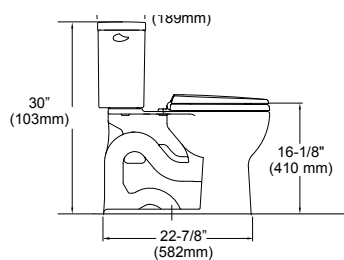
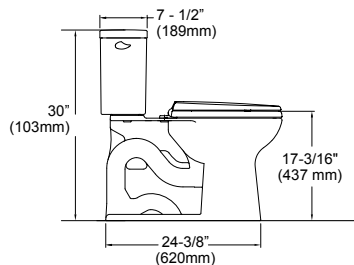
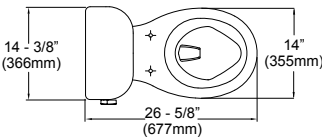
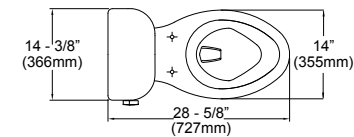
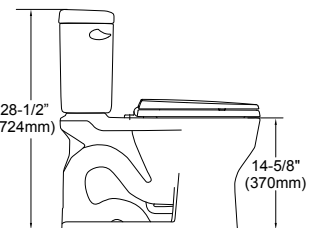
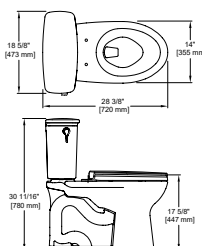

For more information on dimensions please refer to product spec sheet.

AVAILABLE  
COLOR  #01  
Cotton

# COMMERCIAL TOILETS OVERVIEW

**NEW**

**COMMERCIAL FLUSHOMETER HIGH-EFFICIENCY TOILET**  
**1.0/1.28/1.6 GPF**  
 CT725CU(G)



- ▶ TORNADO FLUSH® is a sustainable, high-performance system that effectively removes waste, utilizing 360° of cleaning power to scour the bowl and rim
- ▶ Floor-mounted
- ▶ Elongated front bowl
- ▶ Optional CEFIONTECT ceramic glaze minimizes waste from sticking to porous ceramic surfaces
- ▶ Clear glazed trapway coating
- ▶ 10"-12" rough-in
- ▶ Available in cotton #01 only

**NEW**

**COMMERCIAL FLUSHOMETER HIGH-EFFICIENCY TOILET**  
**1.0/1.28/1.6 GPF**  
 CT725CUF(G)



- ▶ TORNADO FLUSH is a sustainable, high-performance system that effectively removes waste, utilizing 360° of cleaning power to scour the bowl and rim
- ▶ Floor-mounted
- ▶ ADA compliant
- ▶ UNIVERSAL HEIGHT
- ▶ Elongated front bowl
- ▶ Optional CEFIONTECT ceramic glaze minimizes waste from sticking to porous ceramic surfaces
- ▶ Clear glazed trapway coating
- ▶ 10"-12" rough-in
- ▶ Available in cotton #01 only

**NEW**

**COMMERCIAL FLUSHOMETER HIGH-EFFICIENCY WALL-HUNG TOILET**  
**1.0/1.28/1.6 GPF**  
 CT728CU(G)



- ▶ TORNADO FLUSH is a sustainable, high-performance system that effectively removes waste, utilizing 360° of cleaning power to scour the bowl and rim
- ▶ Wall-mounted
- ▶ Elongated front bowl
- ▶ Optional CEFIONTECT ceramic glaze minimizes waste from sticking to porous ceramic surfaces
- ▶ Clear glazed trapway coating
- ▶ Maximum static load rating of 1000 lbs when used with appropriate wall carrier
- ▶ For compatible flush valves, see page 10
- ▶ Available in cotton #01 only

**NEW**

**COMMERCIAL FLUSHOMETER HIGH-EFFICIENCY WALL-HUNG TOILET**  
**1.0/1.28/1.6 GPF**  
 CT728CUV(G)



- ▶ TORNADO FLUSH is a sustainable, high-performance system that effectively removes waste, utilizing 360° of cleaning power to scour the bowl and rim
- ▶ Wall-mounted
- ▶ Elongated front bowl
- ▶ Optional CEFIONTECT ceramic glaze minimizes waste from sticking to porous ceramic surfaces
- ▶ Clear glazed trapway coating
- ▶ Maximum static load rating of 1000 lbs when used with appropriate wall carrier
- ▶ For compatible flush valves, see page 10
- ▶ Available in cotton #01 only

12" rough-in dimensions

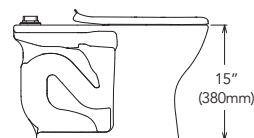
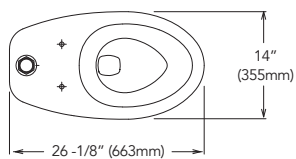

12" rough-in dimensions

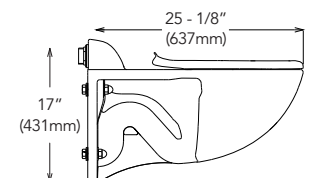
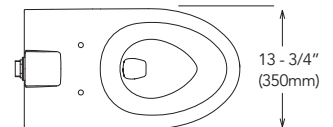
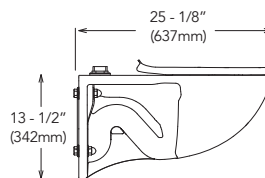
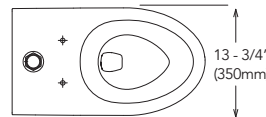
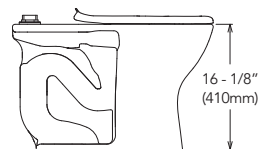
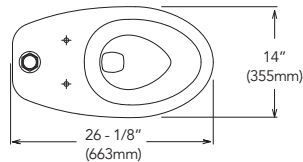

**AVAILABLE COLOR**



For more information on dimensions please refer to product spec sheet.

# TOILET SEATS OVERVIEW

**COMMERCIAL SEAT**  
SC534



- ▶ Elongated open front toilet seat
- ▶ Mounting hardware included

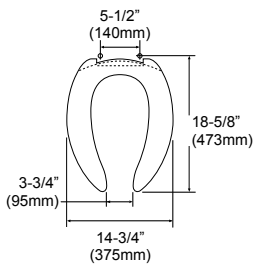

**COMMERCIAL SEAT**  
SC134



- ▶ Open front toilet seat and cover
- ▶ Mounting hardware included

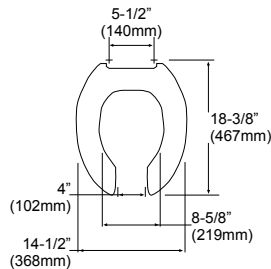

# COMMERCIAL URINALS OVERVIEW

## URINAL FLUSH VALVE

## COMPATIBILITY CHART

	PRODUCT	SKU#		FLUSHOMETER				
				ECOPOWER®			MANUAL	
				0.125 GPF	0.5 GPF	1.0 GPF	0.5 GPF	1.0 GPF
URINAL	Full Size Top Spud	UT445U	Exposed	TEU1UA12#CP				
	Full Size Back Spud	UT445UV	Concealed	TEU2UA11#SS				
				TEU3UA11#SS				
	Compact Top Spud	UT105U(G)	Exposed	TEU1UA12#CP				
	Compact Back Spud	UT105UV(G)	Concealed	TEU2UA11#SS				
				TEU3UA11#SS				
	Full Size Top Spud	UT447E	Exposed		TEU1LA12#CP	TEU1GA12#CP	TMU1LN12#CP	TMU1NNC-12
	Full Size Back Spud	UT447EV	Concealed		TEU2LA11#SS			
					TEU3LA11#SS			
	Compact Top Spud	UT104E	Exposed		TEU1LA12#CP	TEU1GA12#CP	TMU1LN12#CP	TMU1NNC-12
Compact Back Spud	UT104EV	Concealed				TMU1LN22#CP	TMU1NNC-22	
				TEU2LA11#SS				
				TEU3LA11#SS				

For more information on dimensions please refer to product spec sheet.

AVAILABLE  
COLOR



#01  
Cotton



# COMMERCIAL URINALS OVERVIEW

WASHOUT ULTRA  
HIGH-EFFICIENCY URINAL  
0.125 GPF  
UT445U



WASHOUT ULTRA  
HIGH-EFFICIENCY URINAL  
0.125 GPF  
UT445UV



WASHOUT ULTRA  
HIGH-EFFICIENCY URINAL  
0.125 GPF  
UT105U(G)



WASHOUT ULTRA  
HIGH-EFFICIENCY URINAL  
0.125 GPF  
UT105UV(G)



- ▶ Full size urinal with integral trap
- ▶ Washout flush action with 3/4" top spud inlet
- ▶ 0.125 gpf
- ▶ Complete with low profile dome strainer
- ▶ For compatible flush valves, see page 16

- ▶ Full size urinal with concealed integral trap
- ▶ Washout flush action with 3/4" back spud inlet
- ▶ 0.125 gpf
- ▶ Complete with low profile dome strainer
- ▶ For compatible flush valves, see page 16

- ▶ Compact urinal with integral trap
- ▶ Washout flush action with 3/4" top spud inlet
- ▶ 0.125 GPF
- ▶ Complete with low profile dome strainer
- ▶ Optional CEFIONTECT® glaze prevents debris from sticking to ceramic surfaces, making them easier to clean
- ▶ For compatible flush valves, see page 16

- ▶ Compact urinal with concealed integral trap
- ▶ Washout flush action with 3/4" back spud inlet
- ▶ 0.125 GPF
- ▶ Complete with low profile dome strainer
- ▶ Optional CEFIONTECT glaze prevents debris from sticking to ceramic surfaces, making them easier to clean
- ▶ For compatible flush valves, see page 16

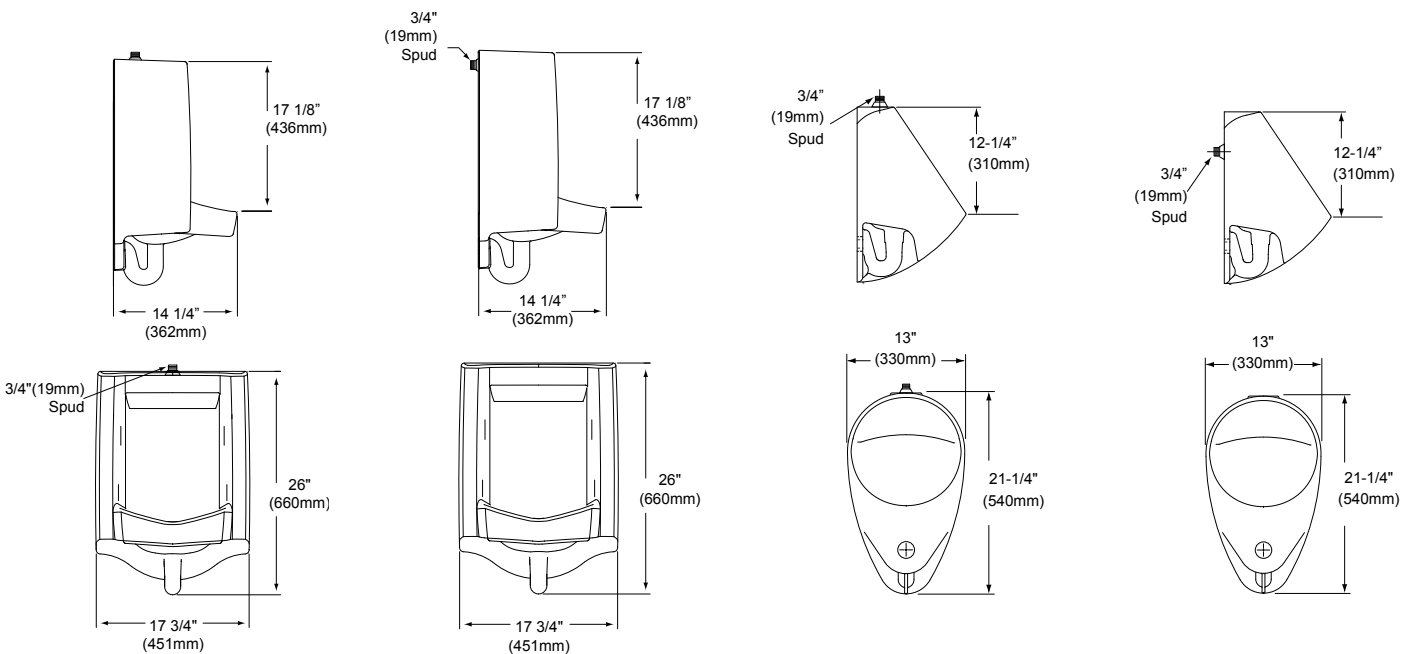

For more information on dimensions please refer to product spec sheet.

AVAILABLE  
COLOR



# COMMERCIAL URINALS

## OVERVIEW

WASHOUT HIGH-EFFICIENCY URINAL  
0.5 GPF  
UT447E

WASHOUT HIGH-EFFICIENCY URINAL  
0.5 GPF  
UT447EV

WASHOUT HIGH-EFFICIENCY URINAL  
0.5 GPF  
UT104E

WASHOUT HIGH-EFFICIENCY URINAL  
0.5 GPF  
UT104EV



- ▶ Full size urinal with concealed integral trap
- ▶ Washout flush action with 3/4" top spud inlet
- ▶ 0.5 gpf
- ▶ For compatible flush valves, see page 16

- ▶ Full size urinal with concealed integral trap
- ▶ Washout flush action with 3/4" back spud inlet
- ▶ 0.5 gpf
- ▶ For compatible flush valves, see page 16

- ▶ Compact urinal with concealed integral trap
- ▶ Washout flush action with 3/4" top spud inlet
- ▶ 0.5 gpf
- ▶ For compatible flush valves, see page 16

- ▶ Compact urinal with concealed integral trap
- ▶ Washout flush action with 3/4" back spud inlet
- ▶ 0.5 gpf
- ▶ For compatible flush valves, see page 16

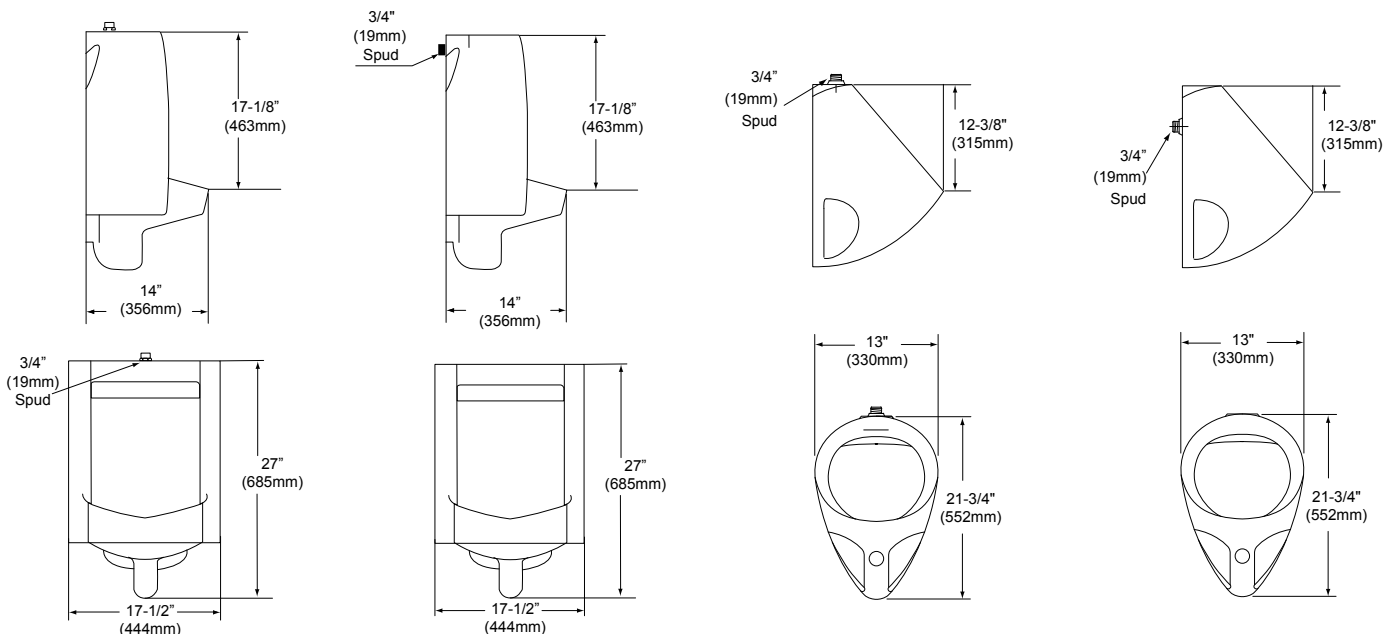

AVAILABLE  
COLOR



For more information on dimensions please refer to product spec sheet.

# THE POWER OF RECLAIMED WATER

Innovation & Technology Highlights

## COMMITTED TO SAVING WATER DROP BY DROP.



Water conservation extends far beyond the amount we use. Reclaimed water aims to reduce the amount of potable water used in our toilet systems. Recycling water already used for toilets conserves our precious, finite sources of fresh water.

# COMMERCIAL TOILETS OVERVIEW

**NEW**

**COMMERCIAL FLUSHOMETER FLOOR-MOUNTED TOILET**  
**1.0/1.28 GPF**  
 CT725CU(G)X



- ▶ TORNADO FLUSH® is a sustainable, high-performance system that effectively removes waste, utilizing 360° of cleaning power to scour the bowl and rim
- ▶ Floor-mounted
- ▶ Elongated front bowl
- ▶ Optional CEFIONTECT® ceramic glaze minimizes waste from sticking to porous ceramic surfaces
- ▶ Clear glazed trapway coating
- ▶ 10"-12" rough-in
- ▶ Designed for reclaimed water use
- ▶ Available in cotton #01 only

**NEW**

**COMMERCIAL FLUSHOMETER ADA FLOOR-MOUNTED TOILET**  
**1.0/1.28 GPF**  
 CT725CUF(G)X



- ▶ TORNADO FLUSH is a sustainable, high-performance system that effectively removes waste, utilizing 360° of cleaning power to scour the bowl and rim
- ▶ Floor-mounted
- ▶ ADA compliant
- ▶ UNIVERSAL HEIGHT
- ▶ Elongated front bowl
- ▶ Optional CEFIONTECT ceramic glaze minimizes waste from sticking to porous ceramic surfaces
- ▶ Clear glazed trapway coating
- ▶ 10"-12" rough-in
- ▶ Designed for reclaimed water use
- ▶ Available in cotton #01 only

**NEW**

**COMMERCIAL FLUSHOMETER TOP SPUD WALL-HUNG TOILET**  
**1.0/1.28 GPF**  
 CT728CU(G)X



- ▶ TORNADO FLUSH is a sustainable, high-performance system that effectively removes waste, utilizing 360° of cleaning power to scour the bowl and rim.
- ▶ Wall-mounted
- ▶ Elongated front bowl
- ▶ Optional CEFIONTECT ceramic glaze minimizes waste from sticking to porous ceramic surfaces
- ▶ Clear glazed trapway coating
- ▶ Designed for reclaimed water use
- ▶ Maximum static load rating of 1000 lbs when used with appropriate wall carrier
- ▶ For compatible flush valves, see page 21
- ▶ Available in cotton #01 only

12" rough-in dimensions

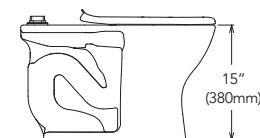
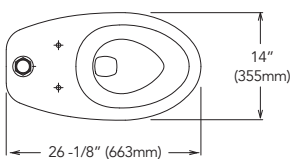

12" rough-in dimensions

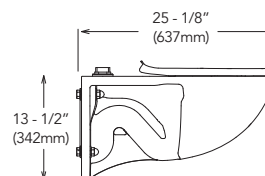
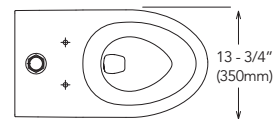
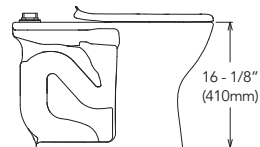
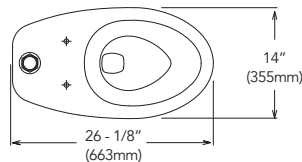

**AVAILABLE COLOR**



For more information on dimensions please refer to product spec sheet.

# TOILET FLUSH VALVES

## OVERVIEW

NEW

### ECOPOWER EXPOSED TOILET FLUSH VALVE

TET1UBX - 1.0 GPF  
TET1LBX - 1.28 GPF



- ▶ Designed with robust materials necessary for reclaimed water use
- ▶ Self-powered hydroelectric flush valve system
- ▶ No minimum daily usage requirement
- ▶ Durable chrome plated body with tamperproof screws and solid bronze valve body
- ▶ Self-cleaning piston valve with 360° filter screen
- ▶ Neutral rough-in and adjustable tail piece connection
- ▶ True mechanical flush override
- ▶ Smart sensor with self-adjusting detection range
- ▶ 6 second detection time to prevent ghost flushing
- ▶ For toilet with 1-1/2" top spud inlet
- ▶ Exposed flush valve with 1" angle stop and 1-1/2" vacuum breaker set
- ▶ Contributes to earning credits in LEED®
- ▶ Protects trap seal with a maintenance flush if not used in a 24 hr period
- ▶ ADA compliant

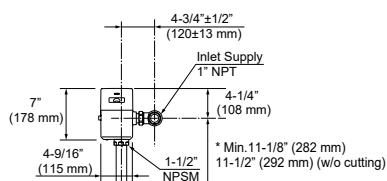

AVAILABLE  
FINISH

#CP  
Polished  
Chrome

For more information on dimensions please refer to product spec sheet.

# COMMERCIAL URINALS OVERVIEW

**WASHOUT HIGH-EFFICIENCY URINAL**  
**0.5 GPF**  
UT447EX



- ▶ Designed for reclaimed water
- ▶ Full size urinal with concealed integral trap
- ▶ Washout flush action with 3/4" top spud inlet
- ▶ For compatible flush valves, see page 23
- ▶ ADA compliant

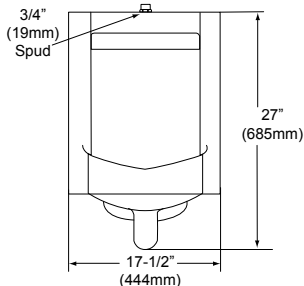
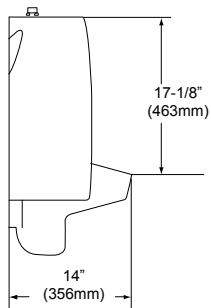

**WASHOUT ULTRA HIGH-EFFICIENCY URINAL**  
**0.125 GPF**  
UT445UX



- ▶ Designed for reclaimed water
- ▶ Full size urinal with integral trap
- ▶ Washout flush action with 3/4" top spud inlet
- ▶ Complete with low profile dome strainer
- ▶ For compatible flush valves, see page 23
- ▶ ADA compliant

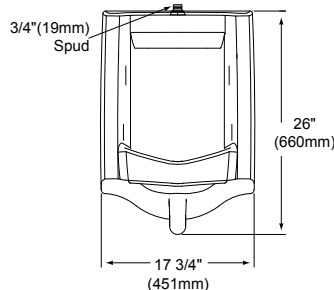
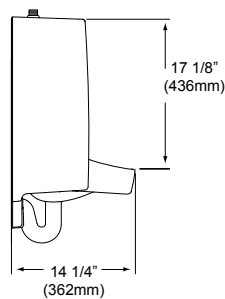

**WASHOUT HIGH-EFFICIENCY URINAL**  
**0.5 GPF**  
UT104EX



- ▶ Designed for reclaimed water
- ▶ Compact urinal with concealed integral trap
- ▶ Washout flush action with 3/4" top spud inlet
- ▶ For compatible flush valves, see page 23
- ▶ ADA compliant

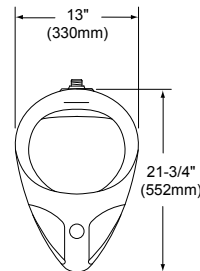
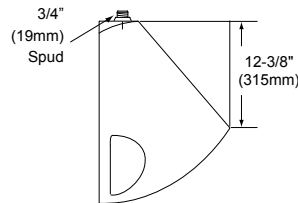

**WASHOUT ULTRA HIGH-EFFICIENCY URINAL**  
**0.125 GPF**  
UT105U(G)X



- ▶ Designed for reclaimed water
- ▶ Compact urinal with integral trap
- ▶ Washout flush action with 3/4" top spud inlet
- ▶ Complete with low profile dome strainer
- ▶ Optional CEFIONTECT® glaze prevents debris from sticking to ceramic surfaces, making them easier to clean
- ▶ For compatible flush valves, see page 23
- ▶ ADA compliant

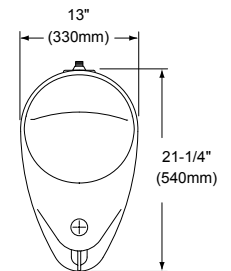
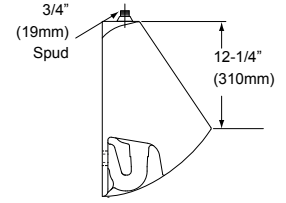

**AVAILABLE  
COLOR**



For more information on dimensions please refer to product spec sheet.



# URINAL FLUSH VALVES

## OVERVIEW

### ECOPOWER EXPOSED URINAL FLUSH VALVE

TEU1UAX - 0.125 GPF

TEU1LAX - 0.5 GPF



- ▶ Designed with robust materials necessary for reclaimed water
- ▶ Self-powered hydroelectric flush valve system
- ▶ No minimum daily usage requirement
- ▶ Durable chrome plated body with tamper-proof screws and solid bronze valve body with EPD coating
- ▶ Self-cleaning piston valve with 360° filter screen
- ▶ Neutral rough-in and adjustable tail piece connection
- ▶ True mechanical flush override
- ▶ Smart sensor with self-adjusting detection range
- ▶ 6-second detection time to prevent ghost flushing
- ▶ ADA compliant

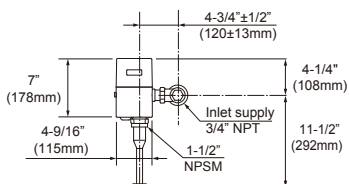

AVAILABLE  
FINISH



For more information on dimensions please refer to product spec sheet.

# The security of TOUCHLESS

A new world. A better way to clean.





# COMMERCIAL TOUCHLESS RESTROOMS



## Offer a Clean, Comfortable Experience and Help Protect the Environment

Today more than ever before, patrons want to decrease public restroom touchpoints as much as possible. From no-touch faucets and flush valves to automatic soap dispensers and hand dryers, TOTO's hands-free products give patrons confidence that their restroom experience will be clean, comfortable, and convenient. In addition, TOTO's stylish, high-performance sensor products save energy, water, time, and money without sacrificing an ounce of performance. Facilities around the globe choose TOTO's innovative sensor products for their public restrooms to offer patrons a clean, comfortable experience and help protect the environment.

[www.totousa.com/touchless](http://www.totousa.com/touchless)



SCAN CODE  
TO PLAY VIDEO







# TOILET FLUSH VALVES OVERVIEW

**NEW**

## ECOPOWER® CONCEALED TOILET FLUSH VALVE

- TET2UB - 1.0 GPF
- TET2LB - 1.28 GPF
- TET2GB - 1.6 GPF



- ▶ Self-powered hydroelectric flush valve system
- ▶ No minimum daily usage requirement
- ▶ Heavy duty 14" x 12" stainless steel cover plate with satin finish and solid bronze valve body
- ▶ Self-cleaning piston valve with 360° filter screen
- ▶ Neutral rough-in and adjustable tail piece connection
- ▶ Manual flush override
- ▶ Smart sensor with self-adjusting detection range
- ▶ 6 second detection time to prevent ghost flushing
- ▶ Concealed flush valve with 1" angle stop and 1-1/2" vacuum breaker set
- ▶ \*Contributes to earning credits in LEED®
- ▶ Protects trap seal with a maintenance flush if not used in a 24 hr period
- ▶ ADA compliant
- ▶ Available in Stainless Steel (#SS) only

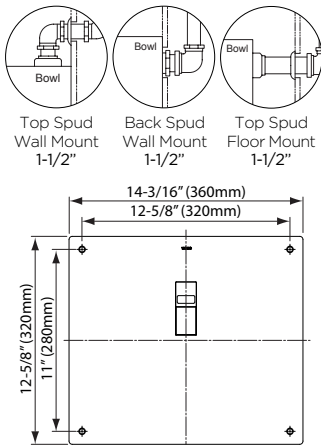

**NEW**

## ECOPOWER CONCEALED TOILET FLUSH VALVE

- TET3UB- 1.0 GPF
- TET3LB - 1.28 GPF
- TET3GB - 1.6 GPF



- ▶ Self-powered hydroelectric flush valve system
- ▶ No minimum daily usage requirement
- ▶ 4" x 4" stainless steel cover plate with brushed satin finish and solid bronze valve body
- ▶ Self-cleaning piston valve with 360° filter screen
- ▶ Neutral rough-in and adjustable tail piece connection
- ▶ Manual flush override
- ▶ Smart sensor with self-adjusting detection range
- ▶ 6 second detection time to prevent ghost flushing
- ▶ Concealed flush valve with 1" angle stop and 1-1/2" vacuum breaker set
- ▶ \*Contributes to earning credits in LEED
- ▶ Protects trap seal with a maintenance flush if not used in a 24 hr period
- ▶ ADA compliant
- ▶ Available in Stainless Steel (#SS) only

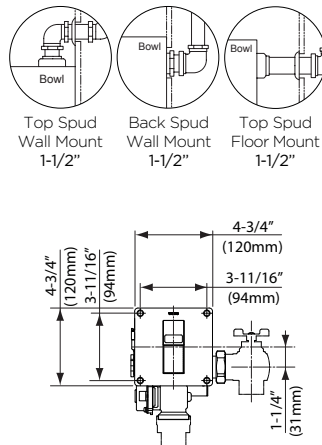

**NEW**

## ECOPOWER EXPOSED TOILET FLUSH VALVE

- TET1UB - 1.0 GPF
- TET1LB - 1.28 GPF
- TET1GB - 1.6 GPF



- ▶ Self-powered hydroelectric flush valve system
- ▶ No minimum daily usage requirement
- ▶ Durable chrome plated body with tamper proof screws and solid bronze valve body
- ▶ Self-cleaning piston valve with 360° filter screen
- ▶ Neutral rough-in and adjustable tail piece connection
- ▶ True mechanical flush override
- ▶ Smart sensor with self-adjusting detection range
- ▶ 6 second detection time to prevent ghost flushing
- ▶ For toilet with 1-1/2" top spud inlet
- ▶ Exposed flush valve with 1" angle stop and 1-1/2" vacuum breaker set
- ▶ \*Contributes to earning credits in LEED
- ▶ Protects trap seal with a maintenance flush if not used in a 24 hr period
- ▶ ADA compliant
- ▶ Available in Polished Chrome (#CP) only

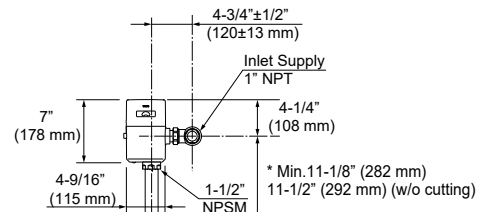

\*Only applies to 1.28 & 1.0 GPF toilet flush valves.

For more information on dimensions please refer to product spec sheet.

# TOILET FLUSH VALVES OVERVIEW

**NEW**

## ECOPOWER EXPOSED 24" VACUUM BREAKER TOILET FLUSH VALVE

TET6UB - 1.0 GPF  
TET6LB - 1.28 GPF  
TET6GB - 1.6 GPF



- ▶ Self-powered hydroelectric flush valve system
- ▶ No minimum daily usage requirement
- ▶ Durable chrome plated body with tamper-proof screws and solid bronze valve body
- ▶ Self-cleaning piston valve with 360° filter screen
- ▶ Neutral rough-in and adjustable tail piece connection
- ▶ True mechanical flush override
- ▶ Smart sensor with self-adjusting detection range
- ▶ 6-second detection time to prevent ghost flushing
- ▶ For toilet with 1-1/2" top spud inlet using 24" vacuum breaker bar
- ▶ \*Contributes to earning credits in LEED
- ▶ ADA compliant
- ▶ Available in Polished Chrome (#CP) only

## MANUAL TOILET FLUSH VALVE

TMT1LN32 - 1.28 GPF  
TMT1NNC-32 - 1.6 GPF



- ▶ Manual operated, non-hold open, toilet flush valve complete with 1" angle stop and 1-1/2" vacuum breaker set
- ▶ Piston valve action with 1.28/1.6 GPF
- ▶ Left/right rough-in
- ▶ Top spud exposed
- ▶ ADA compliant
- ▶ Available in Polished Chrome (#CP) only

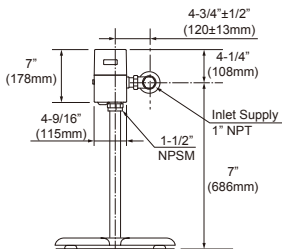

For more information on dimensions please refer to product spec sheet.

### AVAILABLE FINISHES

#SS  
Stainless Steel

#CP  
Polished  
Chrome

\*Only applies to 1.28 & 1.0 GPF toilet flush valves.





# URINAL FLUSH VALVES OVERVIEW

## ECOPOWER CONCEALED URINAL FLUSH VALVE

TEU2UAR - 0.125 GPF  
TEU2LAR - 0.5 GPF



- ▶ Self-powered hydroelectric flush valve system
- ▶ No minimum daily usage requirement
- ▶ 14" x 12" stainless steel cover plate with solid bronze valve body
- ▶ Neutral rough-in and adjustable tail piece connection
- ▶ Self-cleaning piston valve with 360° filter screen†
- ▶ Manual flush override
- ▶ Smart sensor with self-adjusting detection range
- ▶ 6-second detection time to prevent ghost flushing
- ▶ ADA compliant
- ▶ Available in Stainless Steel (#SS) only

## ECOPOWER CONCEALED URINAL FLUSH VALVE

TEU3UAR - 0.125 GPF  
TEU3LAR - 0.5 GPF



- ▶ Self-powered hydroelectric flush valve system
- ▶ No minimum daily usage requirement
- ▶ 4" x 4" brushed stainless steel cover plate with solid bronze valve body
- ▶ Neutral rough-in and adjustable tail piece connection
- ▶ Self-cleaning piston valve with 360° filter screen†
- ▶ Manual flush override
- ▶ Smart sensor with self-adjusting detection range
- ▶ 6-second detection time to prevent ghost flushing
- ▶ ADA compliant
- ▶ Available in Stainless Steel (#SS) only

## ECOPOWER EXPOSED URINAL FLUSH VALVE

TEU1UAR - 0.125 GPF  
TEU1LAR - 0.5 GPF  
TEU1GAR - 1.0 GPF



- ▶ Self-powered hydroelectric flush valve system
- ▶ No minimum daily usage requirement
- ▶ Durable chrome plated body with tamper-proof screws and solid bronze valve body
- ▶ Self-cleaning piston valve with 360° filter screen†
- ▶ Neutral rough-in and adjustable tail piece connection
- ▶ True mechanical flush override
- ▶ Smart sensor with self-adjusting detection range and fuzzy logic control† to reduce water usage
- ▶ 6-second detection time to prevent ghost flushing
- ▶ ADA compliant
- ▶ Available in Polished Chrome (#CP) only

## MANUAL URINAL FLUSH VALVE

TMU1LN12 - 0.5 GPF  
TMU1NNC-12 - 1.0 GPF



- ▶ Manual operated, non-hold open, urinal flush valve complete with 3/4" angle stop and 3/4" or 1-1/4" vacuum breaker set
- ▶ Piston valve action with 0.5/1.0 gpf
- ▶ Left/right rough-in
- ▶ Top spud exposed
- ▶ ADA compliant
- ▶ Available in Polished Chrome (#CP) only

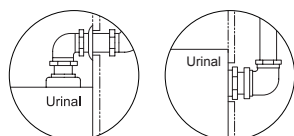

Top Spud  
Wall Mount  
3/4"

Back Spud  
Wall Mount  
1-1/2" & 1-1/4"

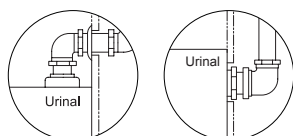

Top Spud  
Wall Mount  
3/4"

Back Spud  
Wall Mount  
1-1/2" & 1-1/4"

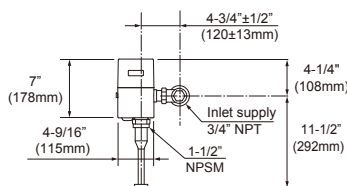
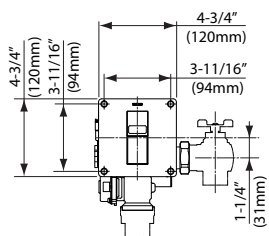
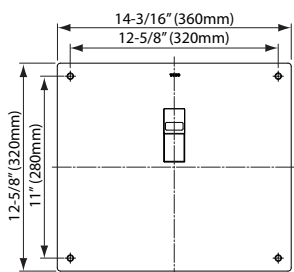

### AVAILABLE FINISHES



#SS  
Stainless Steel



#CP  
Polished  
Chrome

\*Only applies to 0.5 GPF & 0.125 GPF urinal flush valves.

†Only applies to 0.125 GPF urinal flush valves.

‡ Feature available on specific models.

For more information on dimensions please refer to product spec sheet.



Product Shown: Helix® ECOPOWER® Faucet

# COMMERCIAL ECOPOWER® FAUCETS

Innovation & Technology Highlights



ECOPOWER harnesses the energy of running water to power TOTO smart-sensor faucets or flush valves' electronics, replenishing them with every use. No minimum daily usage requirement, which translates into **reduced electricity use**, lower maintenance costs, and better ecology.

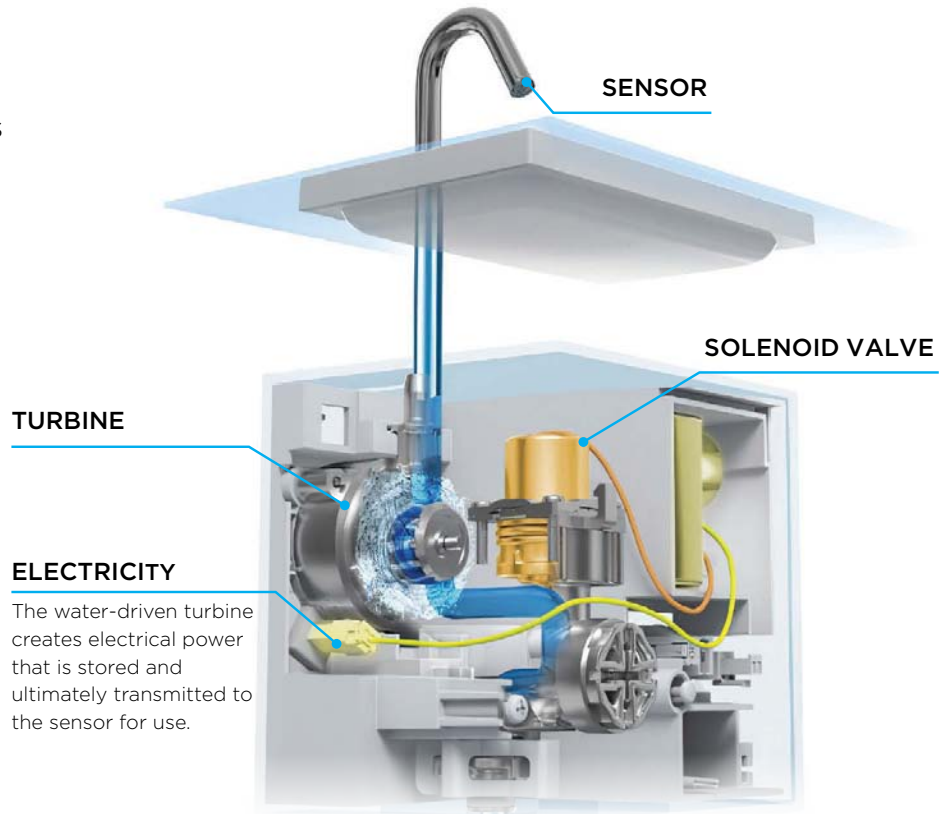

## ELECTRICITY

The water-driven turbine creates electrical power that is stored and ultimately transmitted to the sensor for use.

## ECOPOWER ADVANTAGE

- ▶ Sustainably engineered to require no external electricity source
- ▶ Hydropower system needs no routine battery replacement which lowers maintenance costs
- ▶ Strategically placed sensor ensures instantaneous water response, minimizing water wastage
- ▶ Hands-free operation reduces the chance of spreading contaminants

## TOTO COMMERCIAL PERFORMANCE

**A WIN-WIN.** Unlike other sensor faucets, ECOPOWER faucets use hydropower to operate the sensor. The flow of water, which meets the most rigorous water saving standards, spins the high-efficiency turbine to both create and store power for operation. TOTO's proprietary sensor technology has been perfected over the past 15 years.

**NEW**

ECOPOWER® OR AC  
TOUCHLESS FAUCET  
0.35 GPM / 1.0 GPM

**KIT (INCLUDES SPOUT & CONTROLLER)**

**0.12 GPC, (20 SEC-ON DEMAND)  
@ 0.35 GPM**

**0.18 GPC, (10 SEC-ON DEMAND)  
@ 1.0 GPM**

PRODUCT	SPOUT	TYPE	SINGLE SUPPLY	HOT/COLD MIXING VALVE	THERMOSTATIC MIXING VALVE	SPOUT	TYPE	SINGLE SUPPLY	HOT/COLD MIXING VALVE	THERMOSTATIC MIXING VALVE
				TLM10	TLE05701U				TLM10	TLE05701U
Axiom	TLE25001U2	ECOPOWER	T25S32E#CP	T25S32EM#CP	T25S32ET#CP					
		AC	T25S32A#CP	T25S32AM#CP	T25S32AT#CP					
Axiom Vessel	TLE25003U2	ECOPOWER	T25T32E#CP	T25T32EM#CP	T25T32ET#CP					
		AC	T25T32A#CP	T25T32AM#CP	T25T32AT#CP					
Axiom Wall-Mount	TLE25005U2	ECOPOWER	T25L32E#CP	T25L32EM#CP	T25L32ET#CP					
		AC	T25L32A#CP	T25L32AM#CP	T25L32AT#CP					
GC	TLE21001U2	ECOPOWER	T21S32E#CP	T21S32EM#CP	T21S32ET#CP					
		AC	T21S32A#CP	T21S32AM#CP	T21S32AT#CP					
GE	TLE20001U2	ECOPOWER	T20S32E#CP	T20S32EM#CP	T20S32ET#CP					
		AC	T20S32A#CP	T20S32AM#CP	T20S32AT#CP					
GM	TLE22001U2	ECOPOWER	T22S32E#CP	T22S32EM#CP	T22S32ET#CP					
		AC	T22S32A#CP	T22S32AM#CP	T22S32AT#CP					
Gooseneck	TLE24001U2	ECOPOWER	T24S32E#CP	T24S32EM#CP	T24S32ET#CP					
		AC	T24S32A#CP	T24S32AM#CP	T24S32AT#CP					
Gooseneck Vessel	TLE24003U2	ECOPOWER	T24T32E#CP	T24T32EM#CP	T24T32ET#CP					
		AC	T24T32A#CP	T24T32AM#CP	T24T32AT#CP					
Helix	TLE26001U2	ECOPOWER	T26S32E#CP	T26S32EM#CP	T26S32ET#CP					
		AC	T26S32A#CP	T26S32AM#CP	T26S32AT#CP					
Helix Vessel	TLE26003U2	ECOPOWER	T26T32E#CP	T26T32EM#CP	T26T32ET#CP					
		AC	T26T32A#CP	T26T32AM#CP	T26T32AT#CP					
Helix Wall Mount	TLE26005U2	ECOPOWER	T26L32E#CP	T26L32EM#CP	T26L32ET#CP					
		AC	T26L32A#CP	T26L32AM#CP	T26L32AT#CP					
Libella Semi-Vessel	TLE23002U2	ECOPOWER	T23M32E#CP	T23M32EM#CP	T23M32ET#CP					
		AC	T23M32A#CP	T23M32AM#CP	T23M32AT#CP					
Libella Wall-Mount	TLE23005U2	ECOPOWER	T23L32E#CP	T23L32EM#CP	T23L32ET#CP					
		AC	T23L32A#CP	T23L32AM#CP	T23L32AT#CP					
Standard-R	TLE28001U2	ECOPOWER	T28S32E#CP	T28S32EM#CP	T28S32ET#CP	TLE28003U1	ECOPOWER	T28S11E#CP	T28S11EM#CP	T28S11ET#CP
		AC	T28S32A#CP	T28S32AM#CP	T28S32AT#CP		AC	T28S11A#CP	T28S11AM#CP	T28S11AT#CP
Standard-S	TLE27001U2	ECOPOWER	T27S32E#CP	T27S32EM#CP	T27S32ET#CP	TLE27003U1	ECOPOWER	T27S11E#CP	T27S11EM#CP	T27S11ET#CP
		AC	T27S32A#CP	T27S32AM#CP	T27S32AT#CP		AC	T27S11A#CP	T27S11AM#CP	T27S11AT#CP

**AVAILABLE VALVES**

HOT/COLD MIXING VALVE	THERMOSTATIC MIXING VALVE (FOR 0.35, 0.5 & 1.0 GPM FAUCETS)
TLM10	TLE05701U



**NEW**

ECOPOWER® OR AC  
TOUCHLESS FAUCET  
0.5 GPM

**KIT (INCLUDES SPOUT & CONTROLLER)**

**0.8 GPC, (10 SEC-ON DEMAND)  
@ 0.5 GPM**      **0.17 GPC, (20 SEC-CONTINUOUS)  
@ 0.5 GPM**

PRODUCT	SPOUT	TYPE	0.8 GPC, (10 SEC-ON DEMAND) @ 0.5 GPM			0.17 GPC, (20 SEC-CONTINUOUS) @ 0.5 GPM				
			SINGLE SUPPLY	HOT/COLD MIXING VALVE	THERMOSTATIC MIXING VALVE	SPOUT	TYPE	SINGLE SUPPLY	HOT/COLD MIXING VALVE	THERMOSTATIC MIXING VALVE
				TLM10	TLE05701U				TLM10	TLE05701U
Axiom	TLE25006U1	ECOPOWER	T25S51E#CP	T25S51EM#CP	T25S51ET#CP	TLE25006U3	ECOPOWER	T25S53E#CP	T25S53EM#CP	T25S53ET#CP
		AC	T25S51A#CP	T25S51AM#CP	T25S51AT#CP		AC	T25S53A#CP	T25S53AM#CP	T25S53AT#CP
Axiom Vessel	TLE25008U1	ECOPOWER	T25T51E#CP	T25T51EM#CP	T25T51ET#CP	TLE25008U3	ECOPOWER	T25T53E#CP	T25T53EM#CP	T25T53ET#CP
		AC	T25T51A#CP	T25T51AM#CP	T25T51AT#CP		AC	T25T53A#CP	T25T53AM#CP	T25T53AT#CP
Axiom Wall-Mount	TLE25010U1	ECOPOWER	T25L51E#CP	T25L51EM#CP	T25L51ET#CP	TLE25010U3	ECOPOWER	T25L53E#CP	T25L53EM#CP	T25L53ET#CP
		AC	T25L51A#CP	T25L51AM#CP	T25L51AT#CP		AC	T25L53A#CP	T25L53AM#CP	T25L53AT#CP
GC	TLE21006U1	ECOPOWER	T21S51E#CP	T21S51EM#CP	T21S51ET#CP	TLE21006U3	ECOPOWER	T21S53E#CP	T21S53EM#CP	T21S53ET#CP
		AC	T21S51A#CP	T21S51AM#CP	T21S51AT#CP		AC	T21S53A#CP	T21S53AM#CP	T21S53AT#CP
GE	TLE20006U1	ECOPOWER	T20S51E#CP	T20S51EM#CP	T20S51ET#CP	TLE20006U3	ECOPOWER	T20S53E#CP	T20S53EM#CP	T20S53ET#CP
		AC	T20S51A#CP	T20S51AM#CP	T20S51AT#CP		AC	T20S53A#CP	T20S53AM#CP	T20S53AT#CP
GM	TLE22006U1	ECOPOWER	T22S51E#CP	T22S51EM#CP	T22S51ET#CP	TLE22006U3	ECOPOWER	T22S53E#CP	T22S53EM#CP	T22S53ET#CP
		AC	T22S51A#CP	T22S51AM#CP	T22S51AT#CP		AC	T22S53A#CP	T22S53AM#CP	T22S53AT#CP
Gooseneck	TLE24006U1	ECOPOWER	T24S51E#CP	T24S51EM#CP	T24S51ET#CP	TLE24006U3	ECOPOWER	T24S53E#CP	T24S53EM#CP	T24S53ET#CP
		AC	T24S51A#CP	T24S51AM#CP	T24S51AT#CP		AC	T24S53A#CP	T24S53AM#CP	T24S53AT#CP
Gooseneck Vessel	TLE24008U1	ECOPOWER	T24T51E#CP	T24T51EM#CP	T24T51ET#CP	TLE24008U3	ECOPOWER	T24T53E#CP	T24T53EM#CP	T24T53ET#CP
		AC	T24T51A#CP	T24T51AM#CP	T24T51AT#CP		AC	T24T53A#CP	T24T53AM#CP	T24T53AT#CP
Helix	TLE26006U1	ECOPOWER	T26S51E#CP	T26S51EM#CP	T26S51ET#CP	TLE26006U3	ECOPOWER	T26S53E#CP	T26S53EM#CP	T26S53ET#CP
		AC	T26S51A#CP	T26S51AM#CP	T26S51AT#CP		AC	T26S53A#CP	T26S53AM#CP	T26S53AT#CP
Helix Vessel	TLE26008U1	ECOPOWER	T26T51E#CP	T26T51EM#CP	T26T51ET#CP	TLE26008U3	ECOPOWER	T26T53E#CP	T26T53EM#CP	T26T53ET#CP
		AC	T26T51A#CP	T26T51AM#CP	T26T51AT#CP		AC	T26T53A#CP	T26T53AM#CP	T26T53AT#CP
Helix Wall-Mount	TLE26010U1	ECOPOWER	T26L51E#CP	T26L51EM#CP	T26L51ET#CP	TLE26010U3	ECOPOWER	T26L53E#CP	T26L53EM#CP	T26L53ET#CP
		AC	T26L51A#CP	T26L51AM#CP	T26L51AT#CP		AC	T26L53A#CP	T26L53AM#CP	T26L53AT#CP
Libella Semi-Vessel	TLE23007U1	ECOPOWER	T23M51E#CP	T23M51EM#CP	T23M51ET#CP	TLE23007U3	ECOPOWER	T23M53E#CP	T23M53EM#CP	T23M53ET#CP
		AC	T23M51A#CP	T23M51AM#CP	T23M51AT#CP		AC	T23M53A#CP	T23M53AM#CP	T23M53AT#CP
Libella Wall-Mount	TLE23010U1	ECOPOWER	T23L51E#CP	T23L51EM#CP	T23L51ET#CP	TLE23010U3	ECOPOWER	T23L53E#CP	T23L53EM#CP	T23L53ET#CP
		AC	T23L51A#CP	T23L51AM#CP	T23L51AT#CP		AC	T23L53A#CP	T23L53AM#CP	T23L53AT#CP
Standard-R	TLE28002U1	ECOPOWER	T28S51E#CP	T28S51EM#CP	T28S51ET#CP	TLE28002U3	ECOPOWER	T28S53E#CP	T28S53EM#CP	T28S53ET#CP
		AC	T28S51A#CP	T28S51AM#CP	T28S51AT#CP		AC	T28S53A#CP	T28S53AM#CP	T28S53AT#CP
Standard-R EWATER+®	TLE31002U1	AC	T28S51S#CP	T28S51SM#CP	T28S51ST#CP					
Standard-S	TLE27002U1	ECOPOWER	T27S51E#CP	T27S51EM#CP	T27S51ET#CP	TLE27002U3	ECOPOWER	T27S53E#CP	T27S53EM#CP	T27S53ET#CP
		AC	T27S51A#CP	T27S51AM#CP	T27S51AT#CP		AC	T27S53A#CP	T27S53AM#CP	T27S53AT#CP

**AVAILABLE VALVES**

<b>HOT/COLD MIXING VALVE</b>	<b>THERMOSTATIC MIXING VALVE (FOR 0.35, 0.5 &amp; 1.0 GPM FAUCETS)</b>
<b>TLM10</b>	<b>TLE05701U</b>

GPC (Gallons Per Cycle) | GPM (Gallons Per Minute)



# TOUCHLESS FAUCETS OVERVIEW

**GE**  
**ECOPOWER FAUCET**  
T20S51E (0.5 GPM/0.09 GPC)  
T20S53E (0.5 GPM/0.19 GPC)  
T20S32E (0.35 GPM/0.12 GPC)  
**AC POWER FAUCET**  
T20S51A (0.5 GPM/0.09 GPC)  
T20S53A (0.5 GPM/0.19 GPC)  
T20S32A (0.35 GPM/0.12 GPC)



**GM**  
**ECOPOWER FAUCET**  
T22S32E (0.5 GPM/0.09 GPC)  
T22S51E (0.5 GPM/0.19 GPC)  
T22S53E (0.35 GPM/0.12 GPC)  
**AC POWER FAUCET**  
T22S32A (0.5 GPM/0.09 GPC)  
T22S51A (0.5 GPM/0.19 GPC)  
T22S53A (0.35 GPM/0.12 GPC)



reddot winner 2021

**GOOSENECK**  
**ECOPOWER FAUCET**  
T24S51E (0.5 GPM/0.09 GPC)  
T24S53E (0.5 GPM/0.19 GPC)  
T24S32E (0.35 GPM/0.12 GPC)  
**AC POWER FAUCET**  
T24S51A (0.5 GPM/0.09 GPC)  
T24S53A (0.5 GPM/0.19 GPC)  
T24S32A (0.35 GPM/0.12 GPC)



reddot winner 2021  
best of the best

**GOOSENECK VESSEL**  
**ECOPOWER FAUCET**  
T24T51E (0.5 GPM/0.09 GPC)  
T24T53E (0.5 GPM/0.19 GPC)  
T24T32E (0.35 GPM/0.12 GPC)  
**AC POWER FAUCET**  
T24T51A (0.5 GPM/0.09 GPC)  
T24T53A (0.5 GPM/0.19 GPC)  
T24T32A (0.35 GPM/0.12 GPC)



reddot winner 2021  
best of the best



- ▶ The choice of self-generating hydropowered ECOPOWER® system or AC system
- ▶ Micro-sensor positioned underneath the spout head provides accurate hand detection and ensures smooth, consistent water distribution
- ▶ Vandal resistant nozzle
- ▶ Aerated flow
- ▶ Durable chrome plated spout body
- ▶ Kit includes spout body, controller box, and mounting hardware (supply lines not included)
- ▶ 0.35 gpm aerated flow
- ▶ Contributes to earning LEED® credits
- ▶ Equipped with 0.35 gpm flow control. 0.12 gpc, 20 sec on-demand flow

- ▶ The choice of self-generating hydropowered ECOPOWER® system or AC system
- ▶ Micro-sensor positioned underneath the spout head provides accurate hand detection and ensures smooth, consistent water distribution
- ▶ Vandal resistant nozzle
- ▶ Aerated flow
- ▶ Durable chrome plated spout body
- ▶ Kit includes spout body, controller box, and mounting hardware (supply lines not included)
- ▶ 0.35 gpm aerated flow
- ▶ Contributes to earning LEED® credits
- ▶ Equipped with 0.35 gpm flow control. 0.12 gpc, 20 sec on-demand flow

- ▶ The choice of self-generating hydropowered ECOPOWER® system or AC system
- ▶ Micro-sensor positioned underneath the spout head provides accurate hand detection and ensures smooth, consistent water distribution
- ▶ SOFT FLOW™ flow for strong water flow without the backsplash
- ▶ Laminar flow
- ▶ Durable chrome plated spout body
- ▶ Kit includes spout body, controller box, and mounting hardware (supply lines not included)
- ▶ 0.35 gpm aerated flow
- ▶ Contributes to earning LEED® credits
- ▶ Equipped with 0.35 gpm flow control. 0.12 gpc, 20 sec on-demand flow

- ▶ The choice of self-generating hydropowered ECOPOWER® system or AC system
- ▶ Micro-sensor positioned underneath the spout head provides accurate hand detection and ensures smooth, consistent water distribution
- ▶ SOFT FLOW™ flow for strong water flow without the backsplash
- ▶ Laminar flow
- ▶ Durable chrome plated spout body
- ▶ Kit includes spout body, controller box, and mounting hardware (supply lines not included)
- ▶ 0.35 gpm aerated flow
- ▶ Contributes to earning LEED® credits
- ▶ Equipped with 0.35 gpm flow control. 0.12 gpc, 20 sec on-demand flow

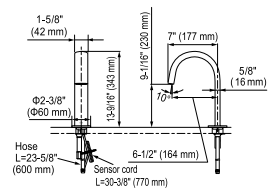
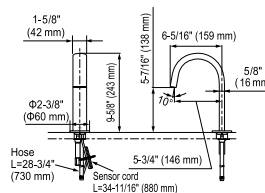
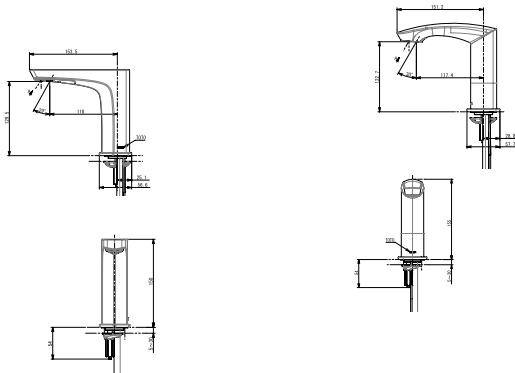

For more information on dimensions please refer to product spec sheet.

**AVAILABLE  
FINISH**



# TOUCHLESS FAUCETS OVERVIEW

**HELIX®  
ECOPOWER FAUCET**  
T26S51E (0.5 GPM/0.09 GPC)  
T26S53E (0.5 GPM/0.19 GPC)  
T26S32E (0.35 GPM/0.12 GPC)  
**AC POWER FAUCET**  
T26S51A (0.5 GPM/0.09 GPC)  
T26S53A (0.5 GPM/0.19 GPC)  
T26S32A (0.35 GPM/0.12 GPC)



**HELIX VESSEL  
ECOPOWER FAUCET**  
T26T51E (0.5 GPM/0.09 GPC)  
T26T53E (0.5 GPM/0.19 GPC)  
T26T32E (0.35 GPM/0.12 GPC)  
**AC POWER FAUCET**  
T26T51A (0.5 GPM/0.09 GPC)  
T26T53A (0.5 GPM/0.19 GPC)  
T26T32A (0.35 GPM/0.12 GPC)



**HELIX WALL-MOUNT  
ECOPOWER FAUCET**  
T26L51E (0.5 GPM/0.09 GPC)  
T26L53E (0.5 GPM/0.19 GPC)  
T26L32E (0.35 GPM/0.12 GPC)  
**AC POWER FAUCET**  
T26L51A (0.5 GPM/0.09 GPC)  
T26L53A (0.5 GPM/0.19 GPC)  
T26L32A (0.35 GPM/0.12 GPC)



**LIBELLA® SEMI-VESSEL  
ECOPOWER FAUCET**  
T23M51E (0.5 GPM/0.09 GPC)  
T23M53E (0.5 GPM/0.19 GPC)  
T23M32E (0.35 GPM/0.12 GPC)  
**AC POWER FAUCET**  
T23M51A (0.5 GPM/0.09 GPC)  
T23M53A (0.5 GPM/0.19 GPC)  
T23M32A (0.35 GPM/0.12 GPC)



- ▶ The choice of self-generating hydropowered ECOPOWER® system or AC system
- ▶ Micro-sensor positioned underneath the spout head provides accurate hand detection and ensures smooth, consistent water distribution
- ▶ Vandal resistant nozzle
- ▶ Aerated flow
- ▶ Durable chrome plated spout body
- ▶ Kit includes spout body, controller box, and mounting hardware (supply lines not included)
- ▶ 0.35 gpm aerated flow
- ▶ Contributes to earning LEED® credits
- ▶ Equipped with 0.35 gpm flow control. 0.12 gpc, 20 sec on-demand flow

- ▶ The choice of self-generating hydropowered ECOPOWER® system or AC system
- ▶ Micro-sensor positioned underneath the spout head provides accurate hand detection and ensures smooth, consistent water distribution
- ▶ Vandal resistant nozzle
- ▶ Aerated flow
- ▶ Durable chrome plated spout body
- ▶ Kit includes spout body, controller box, and mounting hardware (supply lines not included)
- ▶ 0.35 gpm aerated flow
- ▶ Contributes to earning LEED® credits
- ▶ Equipped with 0.35 gpm flow control. 0.12 gpc, 20 sec on-demand flow

- ▶ The choice of self-generating hydropowered ECOPOWER® system or AC system
- ▶ Micro-sensor positioned underneath the spout head provides accurate hand detection and ensures smooth, consistent water distribution
- ▶ Vandal resistant nozzle
- ▶ Aerated flow
- ▶ Durable chrome plated spout body
- ▶ Kit includes spout body, controller box, and mounting hardware (supply lines not included)
- ▶ 0.35 gpm aerated flow
- ▶ Contributes to earning LEED® credits
- ▶ Equipped with 0.35 gpm flow control. 0.12 gpc, 20 sec on-demand flow

- ▶ The choice of self-generating hydropowered ECOPOWER® system or AC system
- ▶ Micro-sensor positioned underneath the spout head provides accurate hand detection and ensures smooth, consistent water distribution
- ▶ Vandal resistant nozzle
- ▶ Aerated flow
- ▶ Durable chrome plated spout body
- ▶ Kit includes spout body, controller box, and mounting hardware (supply lines not included)
- ▶ 0.35 gpm aerated flow
- ▶ Contributes to earning LEED® credits
- ▶ Equipped with 0.35 gpm flow control. 0.12 gpc, 20 sec on-demand flow

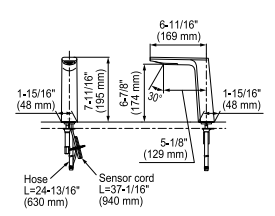
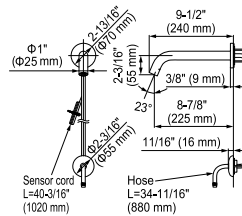
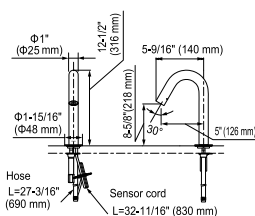
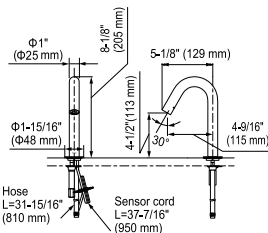

**AVAILABLE  
FINISH**



For more information on dimensions please refer to product spec sheet.



**LIBELLA® WALL-MOUNT L ECOPOWER FAUCET**

- T23L51E (0.5 GPM/0.09 GPC)
- T23L53E (0.5 GPM/0.19 GPC)
- T23L32E (0.35 GPM/0.12 GPC)

**AC POWER FAUCET**

- T23L51A (0.5 GPM/0.09 GPC)
- T23L53A (0.5 GPM/0.19 GPC)
- T23L32A (0.35 GPM/0.12 GPC)



reddot winner 2021



- ▶ The choice of self-generating hydropowered ECOPOWER® system or AC system
- ▶ Micro-sensor positioned underneath the spout head provides accurate hand detection and ensures smooth, consistent water distribution
- ▶ Vandal resistant nozzle
- ▶ Aerated flow
- ▶ Durable chrome plated spout body
- ▶ Kit includes spout body, controller box, and mounting hardware (supply lines not included)
- ▶ Equipped with 0.5 gpm flow control. 0.08 gpc, 10 sec on-demand flow

**STANDARD-R ECOPOWER FAUCET**

- T28S11E (1.0GPM/0.18 GPC)
- T28S51E (0.5 GPM/0.09 GPC)
- T28S53E (0.5 GPM/0.19 GPC)
- T28S32E (0.35 GPM/0.12 GPC)

**AC POWER FAUCET**

- T28S11A (1.0GPM/0.18 GPC)
- T28S51A (0.5 GPM/0.09 GPC)
- T28S53A (0.5 GPM/0.19 GPC)
- T28S32A (0.35 GPM/0.12 GPC)

**AC FAUCET + EWATER**

- T28S51S (0.5 GPM/0.09 GPC)



- ▶ The choice of self-generating hydropowered ECOPOWER® system or AC system
- ▶ Micro-sensor positioned underneath the spout head provides accurate hand detection and ensures smooth, consistent water distribution
- ▶ Vandal resistant nozzle
- ▶ Laminar flow
- ▶ Durable chrome plated spout body
- ▶ Kit includes spout body, controller box, and mounting hardware (supply lines not included)
- ▶ Equipped with 1.0 gpm flow control. 0.18 gpc, 10 sec on-demand flow
- ▶ AC FAUCET + EWATER Only applicable for 0.5gpm and AC type

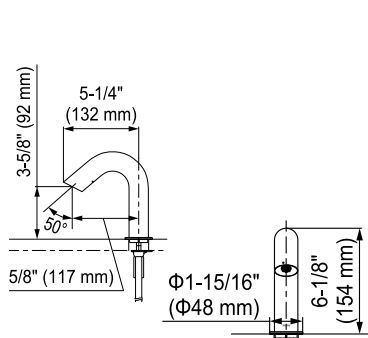

**STANDARD-S ECOPOWER FAUCET**

- T27S11E (1.0 GPM)
- T27S51E (0.5 GPM/ 0.09 GPC)
- T27S53E (0.5 GPM/ 0.19 GPC)
- T27S32E (0.35 GPM/0.12 GPC)

**AC POWER FAUCET**

- T27S11A (1.0 GPM)
- T27S51A (0.5 GPM/ 0.09 GPC)
- T27S53A (0.5 GPM/ 0.19 GPC)
- T27S32A (0.35 GPM/0.12 GPC)



- ▶ The choice of self-generating hydropowered ECOPOWER® system or AC system
- ▶ Micro-sensor positioned underneath the spout head provides accurate hand detection and ensures smooth, consistent water distribution
- ▶ Vandal resistant nozzle
- ▶ Laminar flow
- ▶ Durable chrome plated spout body
- ▶ Kit includes spout body, controller box, and mounting hardware (supply lines not included)
- ▶ Equipped with 1.0 gpm flow control. 0.18 gpc, 10 sec on-demand flow

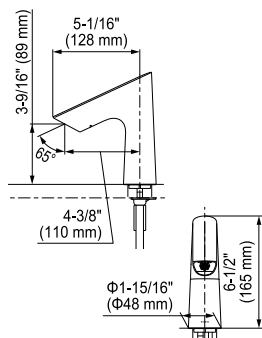

**TOUCHLESS FAUCET CONTROLLER WITH HEATER FAUCET CONTROLLER**

REAH03B1U



- ▶ INTEGRATED hot water system and TOUCHLESS Faucet Controller. (Integrated thermostatic mixing valve is ASSE 1070 compliant.)
- ▶ ECOLOGICAL WITH POWER SAVINGS / Find a time when hot water usage is low and save energy
- ▶ EASY TO INSTALL / Hot water piping system, T&P relief valve and expansion tank are NOT required
- ▶ EASY TO MAINTAIN / No periodical replacement parts
- ▶ SAFETY DESIGN / Tank and Heating element are made of high corrosion-resistance stainless steel
- ▶ EQUIPPED with burnout prevention control of heater elements
- ▶ COMPACT DESIGN / Allows for ADA compliance.
- ▶ For use with 0.5 gpm flow control, 0.08 gpc, 10 sec on-demand flow TOTO Touchless Faucet

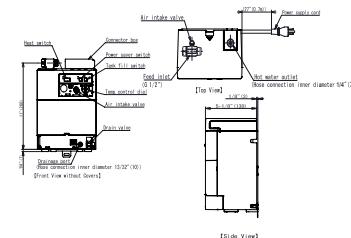

For more information on dimensions please refer to product spec sheet.

AVAILABLE FINISH





TOTO

Products shown: Standard-R Touchless Faucet and Touchless Soap Dispenser

# HANDS-FREE SOAP DISPENSERS

TOTO soap dispensers offer touchless operation with foaming soap for a hygienic handwashing experience.

## TOUCHLESS

### SOAP DISPENSER

- TES201AE (1 spout)
- TES202AE (2 spouts)
- TES203AE (3 spouts)

### SOAP DISPENSER WITH SUBTANK

- TES204AE (2 spouts)
- TES205AE (3 spouts)



## TOUCHLESS

### SOAP DISPENSER - VESSEL

- TES201AG (2 spouts)
- TES202AG (3 spouts)
- TES203AG (4 spouts)

### SOAP DISPENSER WITH SUBTANK

- TES204AG (2 spouts)
- TES205AG (3 spouts)



## TOUCHLESS

### SOAP DISPENSER - ROUND

- TES201AB (1 spout)
- TES202AB (2 spouts)
- TES203AB (3 spouts)

### SOAP DISPENSER - ROUND WITH SUBTANK

- TES204AB (2 spouts)
- TES205AB (3 spouts)



## TOUCHLESS

### SOAP DISPENSER - SEMI-VESSEL

- TES201AF (1 spout)
- TES204AF (2 spouts)
- TES205AF (3 spouts)

### SOAP DISPENSER WITH SUBTANK

- TES204AF (2 spouts)
- TES205AF (3 spouts)



## TOUCHLESS

### SOAP DISPENSER - ROUND VESSEL

- TES201AD (1 spout)
- TES202AD (2 spouts)
- TES203AD (3 spouts)

### SOAP DISPENSER - ROUND VESSEL WITH SUBTANK

- TES204AD (2 spouts)
- TES205AD (3 spouts)



- TOTO's IoT Soap Dispenser alerts your team when the dispenser needs to be refilled or if the controller is leaking
- Micro-sensor under the spout ensures accurate hand detection
- Auto-purge cycle prevents soap from clogging the spout



SCAN CODE TO VIEW SOAP DISPENSERS

\*Available 2021

## TOTO® SOAP 1 GALLON PACKAGE OF 4, 1 GAL. EACH TSFG1

- New FDA compliant, eco-friendly Triclosan-free formulation
- Antibacterial soap effectively reduces up to 99.999% of bacteria during use\*
- Mild lotion soap suitable for daily use
- Use with foaming soap dispenser to create a rich lather for effective hand cleansing and to reduce water consumption

## TOTO SCENTED SOAP 1 GALLON PACKAGE OF 4, 1 GAL. EACH TSFB1-GS

- Green Seal™ GS-41 certified
- No triclosan
- Biodegradable
- Helps qualify for LEED credits

# COMMERCIAL LAVATORIES

Innovation & Technology Highlights

TOTO lavatories deliver the ideal combination of design and functionality. Available in a variety of styles from undercounter to self-rimming, our lavatories offer comfortable use for everyone, regardless of age or physical ability. They're the perfect choice for any commercial space, from hotels to public facilities.



Product shown:  
Rectangle Undercounter Lavatory; LT1535G



**ADA  
COMPLIANT**



The Americans with Disabilities Act (ADA) was enacted in 1990 to establish design codes to serve people of all ages and abilities. A core principle behind TOTO Total Design, ADA standards consider the needs of everyone, no matter their needs, without additional adaptation or specialization, optimizing the bathroom experience for all generations.

# VESSEL LAVATORIES OVERVIEW

**ARVINA®**  
**RECTANGLE VESSEL**  
**LAVATORY**  
LT415G



- ▶ 19-11/16"W x 18-1/8"D x 2-3/4"H
- ▶ CEFIONTECT® ceramic glaze minimizes debris and mold from sticking to surface
- ▶ Inset faucet mount
- ▶ Thin, rounded edges achieving a decorative design
- ▶ Installation template included
- ▶ ADA compliant
- ▶ Front overflow
- ▶ Drain and faucet sold separately

**ARVINA**  
**RECTANGLE VESSEL**  
**LAVATORY**  
LT416G



- ▶ 23-5/8"W x 18-1/8"D x 2-3/4"H
- ▶ CEFIONTECT ceramic glaze minimizes debris and mold from sticking to surface
- ▶ Inset faucet mount
- ▶ Thin, rounded edges achieving a decorative design
- ▶ Installation template included
- ▶ ADA compliant
- ▶ Front overflow
- ▶ Drain and faucet sold separately

**ARVINA**  
**RECTANGLE VESSEL**  
**LAVATORY**  
LT425G



- ▶ 19-11/16"W x 14-15/16"D x 2-3/4"H
- ▶ CEFIONTECT ceramic glaze minimizes debris and mold from sticking to surface
- ▶ Thin, rounded edges achieving a decorative design
- ▶ Installation template included
- ▶ ADA compliant
- ▶ Front overflow
- ▶ Drain sold separately

**ARVINA**  
**RECTANGLE VESSEL**  
**LAVATORY**  
LT426G



- ▶ 23-5/8"W x 14-15/16"D x 2-3/4"H
- ▶ CEFIONTECT ceramic glaze minimizes debris and mold from sticking to surface
- ▶ Thin, rounded edges achieving a decorative design
- ▶ Installation template included
- ▶ ADA compliant
- ▶ Front overflow
- ▶ Drain sold separately

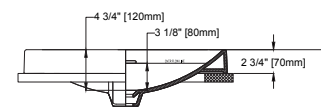
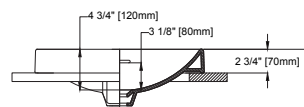
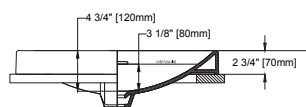
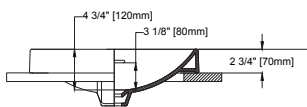
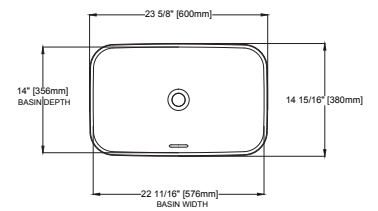
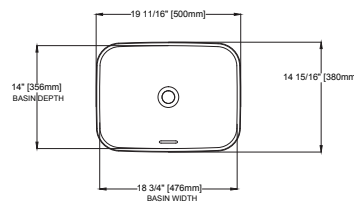
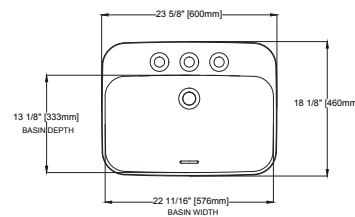
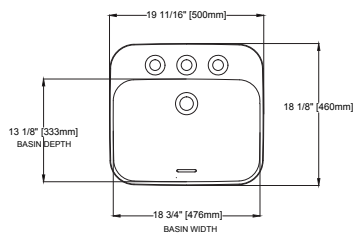

**AVAILABLE  
COLOR**

#01  
Cotton

For more information on dimensions please refer to product spec sheet.



## VESSEL LAVATORIES CONTINUED

ARVINA®  
ROUND VESSEL  
LAVATORY  
LT573



- ▶  $\varnothing$ 16-9/16" Dia. x 4-15/16" H
- ▶ Without overflow
- ▶ Vitreous china
- ▶ ADA compliant
- ▶ Complete with installation template
- ▶ Drain sold separately

ARVINA  
SQUARE VESSEL  
LAVATORY  
LT574



- ▶ 16-9/16" W x 16-9/16" D x 4-15/16" H
- ▶ Without overflow
- ▶ Fireclay
- ▶ ADA compliant
- ▶ Complete with installation template
- ▶ Drain sold separately

## UNDERCOUNTER LAVATORIES OVERVIEW

UNDERCOUNTER  
LAVATORY  
LT569



- ▶ 17" x 14"
- ▶ Oval Undercounter Lavatory
- ▶ ADA compliant
- ▶ Vitreous china
- ▶ Concealed front overflow
- ▶ Mounting assembly complete with installation template, mounting screw set

UNDERCOUNTER  
LAVATORY  
LT587



- ▶ 19" x 15"
- ▶ Oval Undercounter Lavatory
- ▶ ADA compliant
- ▶ Vitreous china
- ▶ Concealed front overflow
- ▶ Mounting assembly complete with installation template, mounting screw set

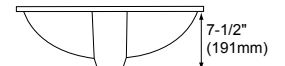
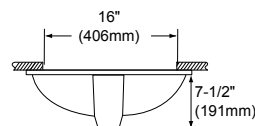
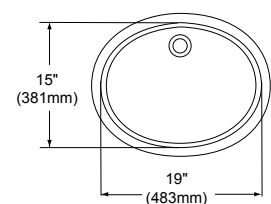
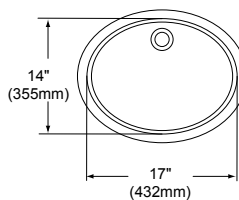
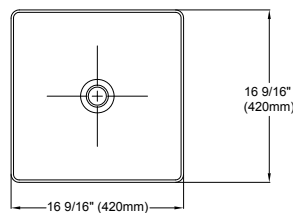
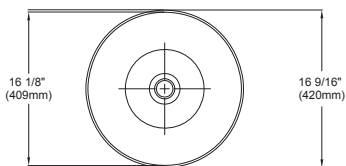

For more information on dimensions please refer to product spec sheet.

AVAILABLE  
COLOR

#01  
Cotton

**RENDEZVOUS**  
**UNDERCOUNTER LAVATORY**  
 LT579(G)



- ▶ 17" x 14"
- ▶ Oval Undercounter Lavatory
- ▶ Optional CEFIONTECT ceramic glaze
- ▶ ADA compliant
- ▶ Vitreous china
- ▶ Mounting assembly complete with installation template and mounting screw set
- ▶ Front overflow

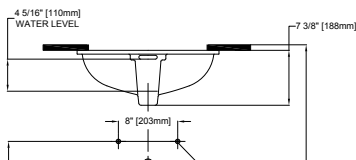
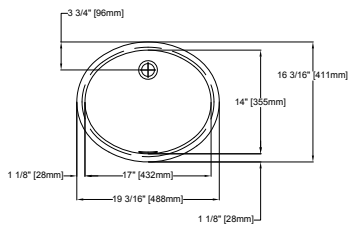

**DANTESCA**  
**UNDERCOUNTER LAVATORY**  
 LT597(G)



- ▶ 19" x 15"
- ▶ Oval Undercounter Lavatory
- ▶ Optional CEFIONTECT ceramic glaze
- ▶ ADA compliant
- ▶ Vitreous china
- ▶ Mounting assembly complete with installation template and mounting screw set
- ▶ Front overflow

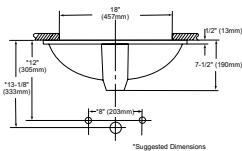
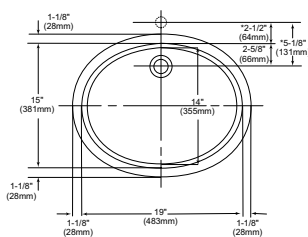

**ATHERTON**  
**UNDERCOUNTER LAVATORY**  
 LT233



- ▶ 19" x 15"
- ▶ Oval Undercounter Lavatory
- ▶ ADA compliant
- ▶ Vitreous china
- ▶ Mounting assembly complete with installation template and mounting screw set
- ▶ Front overflow
- ▶ Available in cotton (#01) only

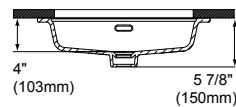
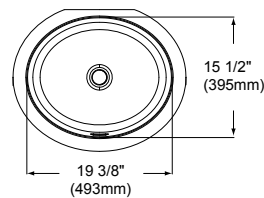

# UNDERCOUNTER LAVATORIES

## OVERVIEW CONTINUED

**UNDERCOUNTER LAVATORY**  
LT1506G



- ▶ 20-7/8" x 13"
- ▶ Oval Undercounter Lavatory
- ▶ CEFIONTECT ceramic glaze
- ▶ ADA compliant
- ▶ Vitreous china
- ▶ Mounting assembly complete with installation template and mounting screw set
- ▶ Front overflow
- ▶ Available in cotton (#01) only

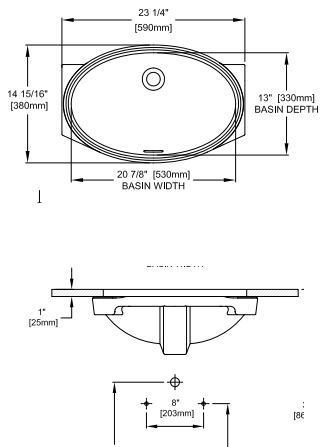

**ATHERTON UNDERCOUNTER LAVATORY**  
LT221



- ▶ 17"x 13"
- ▶ Rectangular Undercounter Lavatory
- ▶ ADA compliant
- ▶ Vitreous china
- ▶ Mounting assembly complete with installation template and mounting screw set
- ▶ Front overflow
- ▶ Available in cotton (#01) only

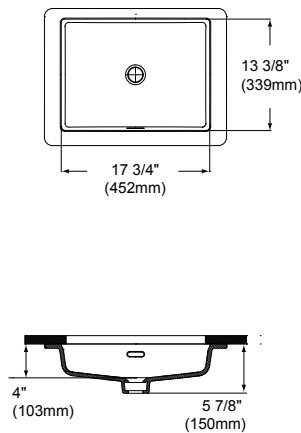

**UNDERCOUNTER LAVATORY**  
LT156



- ▶ 19-3/4" x 13"
- ▶ Rear overflow
- ▶ Fired clay
- ▶ Mounting assembly complete with installation template and mounting screw set
- ▶ Available in cotton (#01) only

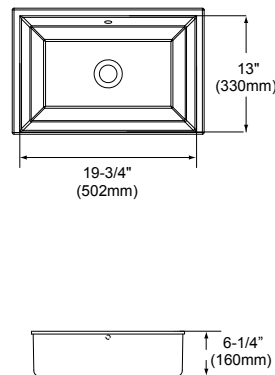

**RECTANGLE UNDERCOUNTER LAVATORY**  
LT540G



- ▶ 21-1/4" x 14-3/8"
- ▶ CEFIONTECT® ceramic glaze
- ▶ ADA compliant
- ▶ Front overflow
- ▶ Mounting assembly complete with installation template and mounting screw set
- ▶ Available in cotton (#01) and sedona beige (#12) only

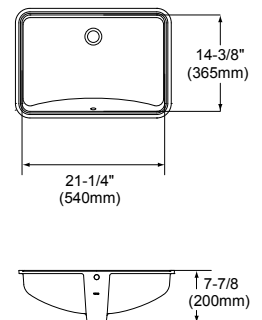

For more information on dimensions please refer to product spec sheet.

### AVAILABLE COLORS



**RECTANGLE UNDERCOUNTER  
LAVATORY**  
LT542G



- ▶ 19" x 12-3/8"
- ▶ CEFIONTECT ceramic glaze
- ▶ ADA compliant
- ▶ Front overflow
- ▶ Mounting assembly complete with installation template and mounting screw set
- ▶ Available in cotton (#01) and sedona beige (#12) only

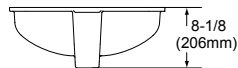
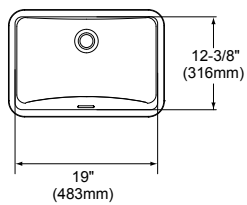

**RECTANGLE UNDERCOUNTER  
LAVATORY**  
LT191(G)



- ▶ 20-1/2" x 12-3/8"
- ▶ Optional CEFIONTECT ceramic glaze
- ▶ ADA compliant
- ▶ Rear overflow
- ▶ Vitreous china
- ▶ Mounting assembly complete with installation template and mounting screw set

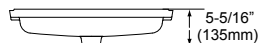
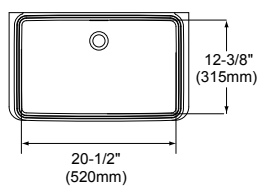

**RECTANGLE UNDERCOUNTER  
LAVATORY**  
LT1535G



- ▶ 17-11/16" x 13"
- ▶ CEFIONTECT ceramic glaze
- ▶ ADA compliant
- ▶ Front overflow
- ▶ Vitreous china
- ▶ Mounting assembly complete with installation template and mounting screw set
- ▶ Available in cotton (#01) only

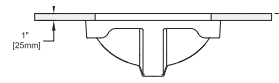
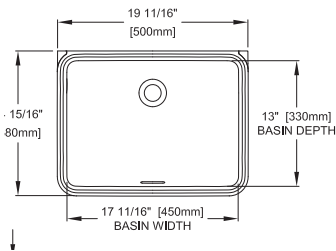

**AVAILABLE  
COLOR**



For more information on dimensions please refer to product spec sheet.

# WHEELCHAIR USER'S LAVATORIES OVERVIEW

**WALL-HUNG  
LAVATORY**  
LT307

**UNDERCOUNTER  
LAVATORY**  
LT308



- ▶ 21" x 18-1/4" lavatory with back splash
- ▶ ADA compliant
- ▶ Vitreous china
- ▶ Punching for concealed arm carrier
- ▶ Wall support concealed arms not supplied by TOTO
- ▶ Includes wall hanger
- ▶ Soap dispenser hole optional
- ▶ Faucet and soap dispenser not included

- ▶ 20-1/2" x 27"
- ▶ ADA compliant
- ▶ Vitreous china
- ▶ Punching for concealed arm carrier
- ▶ Wall support concealed arms not supplied by TOTO
- ▶ No hardware included
- ▶ Faucet not included

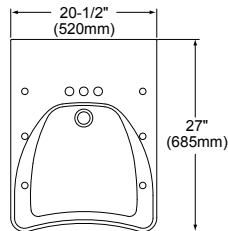
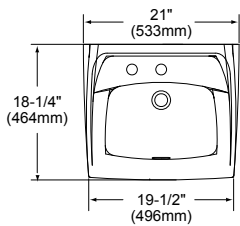





Product shown: Clean Dry® Hand Dryer

# COMMERCIAL CLEAN DRY® HAND DRYERS

Innovation & Technology Highlights

TOTO's Clean Dry hand dryers offer high-speed air for an effective, economical solution. Infrared sensor-operated, Clean Dry offers innovative air wicking technology that dries the user's hands in under 12 seconds.



**WASTE  
REDUCTION**



**LOW  
NOISE**

## TOTO COMMERCIAL PERFORMANCE

Clean Dry hand dryers reduce energy use by 25 percent over traditional electronic hand dryers that sometimes fail to dry hands completely. Further, Clean Dry dryers are extremely quiet during operation with a low decibel rating between 55 and 62 dB

## DECIBEL RATING

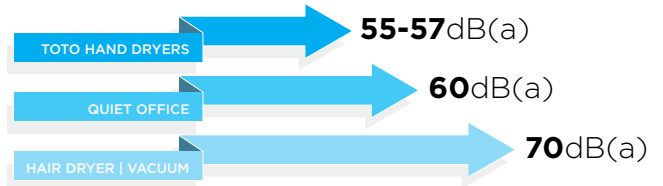

## TOTO HAND DRYER BENEFITS

- ▶ Unobtrusive designs that blend into any bathroom décor
- ▶ Environmentally friendly - no paper waste
- ▶ Eliminates the cost of providing paper towels, including the man-power needed to restock paper and discard trash
- ▶ Double-sided fan simultaneously dries hands from both sides, greatly reducing drying time\*
- ▶ Washable trays to eliminate water splashing and prevent slip and fall accidents
- ▶ Vandal resistant designs

## TOTO HAND DRYERS HELP THE ENVIRONMENT



\*Function available on specific models.

# COMMERCIAL HAND DRYERS OVERVIEW

**CLEAN DRY®  
HIGH SPEED HAND DRYER**  
HDR130#SV

**CLEAN DRY  
HIGH SPEED HAND DRYER**  
HDR101#WH

**CLEAN DRY  
HIGH SPEED HAND DRYER**  
HDR111#SS

**CLEAN DRY  
HIGH SPEED HAND DRYER**  
HDR120#WH



- ▶ High speed hand dryer
- ▶ Hygienic, touch-free operation
- ▶ Durable aluminium construction
- ▶ Low Operating noise 55dB(A)
- ▶ Energy Efficient 390 watts
- ▶ AC powered
- ▶ Available in silver (#SV)

- ▶ High speed hand dryer
- ▶ Hygienic, touch-free operation
- ▶ Splash resistant
- ▶ Water tray to prevent slip and fall
- ▶ Space saving, compact design
- ▶ Low Operating noise 57dB(A)
- ▶ Energy Efficient 390 watts
- ▶ AC powered
- ▶ Available in white (#WH)

- ▶ High speed hand dryer
- ▶ Hygienic, touch-free operation
- ▶ Splash resistant
- ▶ Space saving, in-wall design
- ▶ Vandal proof water tray
- ▶ Low Operating noise 56dB(A)
- ▶ Energy Efficient 390 watts
- ▶ AC powered
- ▶ Stainless Steel Cover
- ▶ Flush mount
- ▶ ADA compliant
- ▶ Available in stainless steel (#SS)

- ▶ Hygienic sensor-activated hand dryer
- ▶ Double-sided blowers for faster dry time
- ▶ Sleek and compact design
- ▶ 208 mph of air speed
- ▶ Side panels and water tray to prevent water from trickling to the floor
- ▶ Low operating noise 57dB(A)
- ▶ Energy efficient
- ▶ Available in white (#WH)

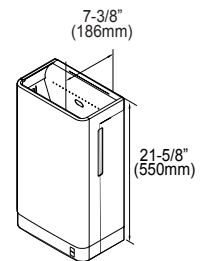
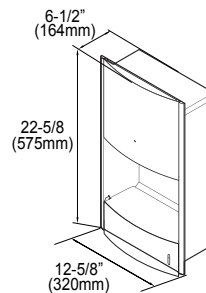
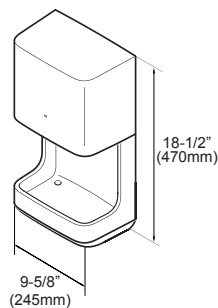
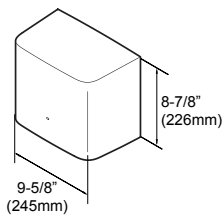

## AVAILABLE FINISHES



For more information on dimensions please refer to product spec sheet.

# WHAT IS THE KOLO™ SMART MONITORING SYSTEM— AND HOW DOES IT MAKE CONNECTED RESTROOMS POSSIBLE?

TOTO's innovative fixtures join GP PRO's proprietary sensors and KOLO communication technology with industry-leading reliability of enMotion and Compact dispensers.



# YOUR ONE-STOP PLATFORM FOR CONNECTING SMART RESTROOMS



Data transmitted from GP PRO dispensers, TOTO fixtures, and third-party devices to collectors.

Data securely uploaded to the internet via wireless communication

Data stored and analyzed in the cloud

Data sent to easy-to-use KOLO™ mobile and desktop applications

Open architecture enables KOLO™ data to be seamlessly integrated into third-party applications



  
**Sink-1**  
Water Not Flowing  
6 min ago

**TOTO**  
  
**Urinal-1**  
Water Running  
21 min ago

**Georgia-Pacific**  
  
**Sanitizer-1**  
Replace Battery  
19 min ago





# WHAT DO MANAGERS HAVE TO SAY?

“ I’m able to address operational issues throughout IoT, and I’m able to address passenger experience through IoT. We have an opportunity to change the game in the restrooms. ”

**DR. KOFI SMITH**  
President & CEO  
Atlanta Airlines Terminal Company  
(2011 to 2020)

## ENHANCE FACILITIES MANAGER EXPERIENCE

Receive real-time notification of restroom issues directly from the KOLO™ Clean App that help staff. The results? Save maintenance time and money while ensuring maximum cleanliness.



### PREVENTATIVE MAINTENANCE

Quality improvement of maintenance, accessible through dashboard, report of actual usage and load information



### INSTANTLY DETECT FAILURES

Promptly identify and address outages

## STREAMLINE CUSTODIAN AND STAFF EXPERIENCE

Leverage data and reports to better manage your restrooms to insure safety and smooth facility operation with the KOLO™ Central Dashboard:



### OPTIMIZE YOUR CLEANING CYCLE

Volume based cleaning  
Work force management  
Air care management



### IMPROVE HYGIENE

Alert staff to check the stall  
Required assistance



### ADVANCED USAGE ANALYTICS

Usage heat-map, labor and space optimization, and future Improvements



## REAL-TIME DASHBOARD



## DASHBOARD

TOTO's IoT Smart Restroom provides a holistic solution for the entire restroom, giving your the ability to remotely manage your facility and fixtures in real-time.

## IMPROVE OPERATIONS. ENHANCE RESTROOM EXPERIENCE.

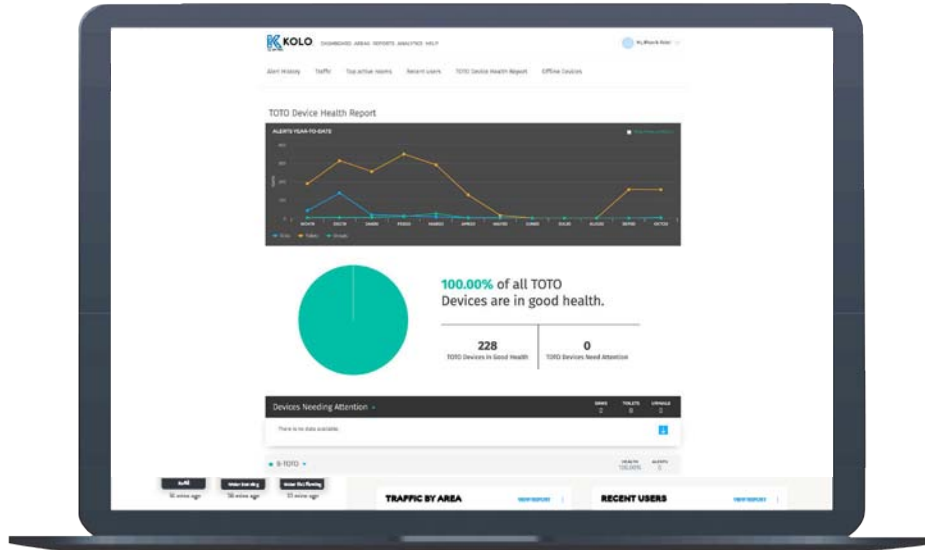

### SYSTEM HEALTH

No matter if you are in a different terminal or at home, you can leverage the connected dashboard to check your system's health, what fixtures need attention, and direct your team to reduce down time.

Facilities managers can now leverage data collected from our TOTO fixtures and our Hand Washing Score\* — helping you decide where to influence new hand washing behaviors to keep your staff and customers safe.

*\*Have the ability to create a Customized Hand Washing Score Report*

### ANALYTICS

Get powerful data and analytics at your fingertips. TOTO's powerful fixtures, combined with IoT driven data empowers you to act on real-time analytics to help improve maintenance and hygiene — saving time and increasing customer satisfaction.

Finally, with TOTO's IoT Smart Restroom, you will fully understand the use of space for future design and plumbing infrastructure improvements.



## ECOPOWER FLUSH VALVES

This self-powered hydroelectric flush valve system generates its own power through turning an internal turbine during every flush. With eco power flush valves, you can rest assured your plumbing fixtures will work -- even during a power outage.

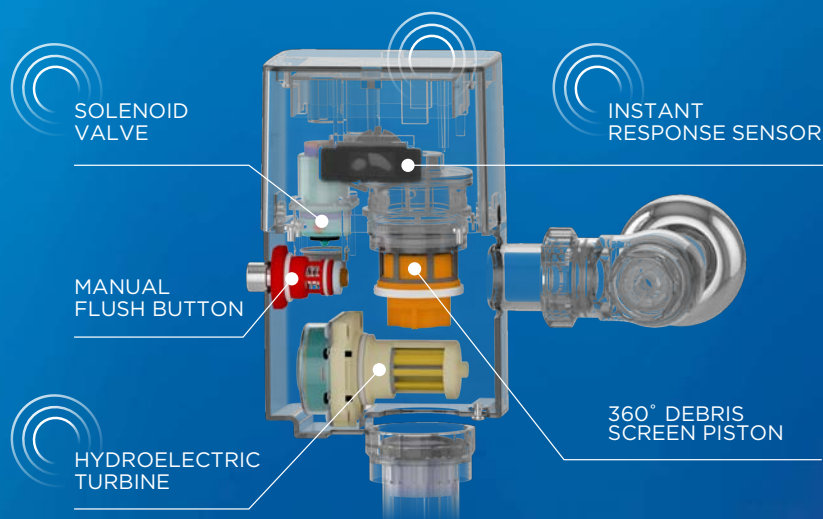





# ECOPOWER® FLUSH VALVES

Hands-free ECOPOWER smart-sensor flush valves for toilet and urinal are energy-saving, durable, and provide maximum performance in even the most demanding, high-traffic public restrooms. This self-powered hydroelectric flush valve system generates its power during use; every time water turns the internal turbine.

## URINAL FLUSH VALVE COMPATIBILITY CHART

				FLUSHOMETER				
				ECOPOWER®			MANUAL	
				0.125 GPF	0.5 GPF	1.0 GPF	0.5 GPF	1.0 GPF
URINAL	Full Size Top Spud	UT445U	Exposed	TEU1UA12i2#CP				
	Full Size Back Spud	UT445UV	Concealed	TEU2UA11i2#SS				
				TEU3UA11i2#SS				
	Compact Top Spud	UT105U(G)	Exposed	TEU1UA12i2#CP				
	Compact Back Spud	UT105UV(G)	Concealed	TEU2UA11i2#SS				
				TEU3UA11i2#SS				
	Full Size Top Spud	UT447E	Exposed		TEU1LA12i2#CP	TEU1GA12i2#CP	TMU1LN12i2#CP	TMU1NNC-12i2
							TMU1LN22i2#CP	TMU1NNC-22i2
	Full Size Back Spud	UT447EV	Concealed		TEU2LA11i2#SS			
					TEU3LA11i2#SS			
Compact Top Spud	UT104E	Exposed		TEU1LA12i2#CP	TEU1GA12i2#CP	TMU1LN12i2#CP	TMU1NNC-12i2	
						TMU1LN22i2#CP	TMU1NNC-22i2	
Compact Back Spud	UT104EV	Concealed		TEU2LA11i2#SS				
				TEU3LA11i2#SS				





## ECOPOWER® FAUCETS

ECOPOWER smart-sensor faucets harness the energy of running water to power themselves, saving water and energy. These hands-free faucets replenish their charge with every use.

## TOUCHLESS FAUCETS



**TOUCHLESS**



**INSTANT  
RESPONSE**

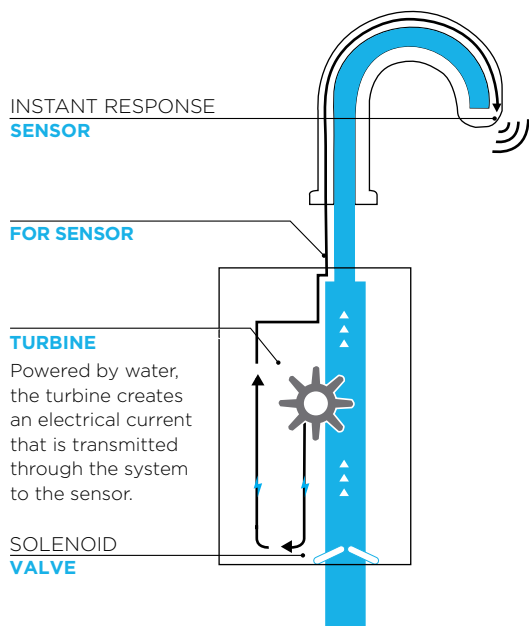

- No minimum daily usage required
- Reduced electricity
- Lower maintenance costs
- Better ecology
- Hands-free, automatic-shut-off



SCAN CODE  
TO VIEW  
ECOPOWER FAUCETS

*Consult your TOTO Representative for more information concerning IoT Faucets*





**SCAN CODE NOW**  
FOR DIGITAL COMMERCIAL BROCHURE



[CATALOG.TOTOUSA.COM](http://CATALOG.TOTOUSA.COM)

**TOTO USA, INC.**  
1155 SOUTHERN ROAD  
MORROW, GA 30260  
800-350-8686

**[www.totousa.com](http://www.totousa.com)**  
**[www.washlet.com](http://www.washlet.com)**

#KO-032023-CB  
Printed in the U.S.A. 03/23